

#27

SWISSPEARL ARCHITECTURE



SWISS
pearl®

#27

SWISSPEARL ARCHITECTURE
TABLE OF CONTENTS

- 2 **RED BARN, WESTPORT,
CONNECTICUT, USA**
Roger Ferris & Partners
- 17 **FOREWORD**
Marco Steg, CEO
- 18 **KNOW-HOW**
How Are Fiber Cement Panels Created?
- 28 **DESIGN**
Sitting Outside: Stool G59/11
- 30 **EMPLOYEE PORTRAIT**
Rahel Studer, Logistics Assistant and In-House Medic
- 36 **MAKING-OF**
Shaped by Hand
- 42 **HOUSE EXTENSION BLACK BOX II, CANADA**
Natalie Dionne Architecture
- 48 **RESIDENTIAL BUILDING SALAINO 10, ITALY**
Antonio Citterio Patricia Viel
- 54 **AURORA BUILDINGS, AUSTRALIA**
Cox Architecture
- 58 **LABORATORIES AND OFFICE BUILDING, SWEDEN**
White Arkitekter
- 64 **TARTU UNIVERSITY HOSPITAL, ESTONIA**
AW2 Architects
- 70 **VARINA AREA LIBRARY, USA**
BCWH Architecture/Tappé Architects
- 74 **HOUSE XL, SLOVENIA**
SoNo Architects
- 78 **HOUSE B4, FRANCE**
Kauffmann & Wassmer
- 82 **BLACK VILLA, USA**
Design 21
- 88 **VILLA FAUN, NORWAY**
Various Architects
- 92 **HOUSE RnEVE, AUSTRIA**
ad2 Architekten
- 97 **FLASH 1: HOUSE ATTERSEE, AUSTRIA**
- 98 **FLASH 2: COLLÈGE DANIEL FAUCHER, FRANCE**
- 99 **FLASH 3: INDUSTRY BUILDING, SWITZERLAND**



ROGER FERRIS & PARTNERS, WESTPORT

Abstracted and Minimal

Red Barn, Westport, Connecticut, USA

Form and surface meld to express the Red Barn's inspiration. The simple gable form and the diminutive outbuilding with its vibrant red exterior recall the typology of a traditional barn. Only upon closer inspection do the glazed ends, entry portal, hangar door, and contemporary cladding denote another reality for the building. The Red Barn's meaning lies somewhere between the past it references and the present it occupies.

Text by John Hill





Although Connecticut is well known as home to numerous corporate headquarters and the grand estates of their executives, historically, the small New England state was predominantly agricultural, even before European settlers displaced the indigenous Indian populations centuries ago. Westport, located in southwestern Connecticut near its small panhandle, is home to 26,391 residents and contains some seventy-five of the state's roughly 8,000 barns. These old farm structures have been repurposed as garages or houses, transported elsewhere, or left alone to decay. Most of the barns that permeate the state and the affluent town of Westport are English barns, sometimes called Connecticut barns: rectangular structures marked by gable roofs at their short ends and doors in the middle of their long, eave sides. Used for dairy farming or tobacco cultivation, these eighteenth- and nineteenth-century barns were covered in wood boards and often painted white or red, making them stand out in the landscape.

Westport's Roger Ferris + Partners has designed a contemporary update of the English barn with the aptly named Red Barn, an art studio and residence on a large waterfront property along the town's so-called Gold Coast.

The Red Barn is one of three buildings on the ten-acre (four hectare) estate of a married couple that includes a large shingle-style house and a small pool house, the latter also designed by architect Roger Ferris and completed since the Red Barn. The property, combined from multiple smaller lots, fronts Long Island Sound, the body of water that separates Connecticut and New York's Long Island. While both the main house and the pool house are oriented to the water, the Red Barn is set back from the shore, situated at the northern end of the site close to the road. The visibility to passing cars pushed Ferris toward the barn form, creating an image recognizable to locals and people well outside of New England. The exterior is covered entirely in red Swisspearl panels that are visibly solid on the long east and west sides but slatted in front of full-height glass walls on the short gable ends facing north and south. The red exterior conceals an artist studio and workshop on the ground floor and upstairs a residence with a bedroom, bathroom, kitchen, and living and dining areas. An off-axis portal lined in Swisspearl pierces the building, further linking the small structure to the English barn typology and providing access to the interior. An overhead hangar door fits seamlessly into the west façade, providing large-scale access to the studio and opening it to the

“Cognizant of history yet rooted in modern materials and construction, the Red Barn is a symbol of something people don't want to forget.”

adjacent yard. The interior of the building is finished simply, with white painted walls and ceilings and wood floors, but—no surprise, given the moniker—the Red Barn is all about the exterior.

The gabled form was reached early in the design process, as was the intent to clad it entirely in one material. Swisspearl's integrally colored Carat panels were selected because of the range of available colors and the product's applicability to vertical, horizontal, and sloped surfaces. Swisspearl covers approximately 9,150 square feet (850 square meters) of exterior wall, roof, and ceiling. The architects chose red Coral 7031 to reinforce the barn imagery, clipping the panels to the steel-and-concrete structure to eliminate visible fasteners and emphasize what Ferris calls the “graphic efficiency” of the building. This efficiency extends to the panels themselves, whose size and spacing unite elevation and plan. The narrow, horizontal panels are stacked in sixteen vertical strips along the long east and west façades, with the plan fitting

logically into the panel spacing: three-wide for the workshop, three-wide for the entry portal, and ten-wide for the studio. The studio's operable door is eight panels wide, but given the open reveals between panels, this industrial feature is invisible when closed, a remarkable feat. Turning the corner, the horizontally striped gable ends are an even six panels

wide, aligned with the vertical frames supporting the glass walls shaded by the slats.

Form and surface meld to clearly express the Red Barn's inspiration. The simple gable form could surely recall other traditional buildings, be it a house or a church or even a shed. Yet with its vibrant red exterior, the diminutive outbuilding only says “barn.” It's on closer inspection that the glazed ends, entry portal, hangar door, and contemporary cladding denote another reality for the building, one more in line with tony Westport this century. In a sense, the Red Barn's meaning lies somewhere between the past it references and the present it occupies. By recalling a typology that is revered yet vanishing, the Red Barn draws attention to the state's agricultural past, one it shares with other New England states. Cognizant of history yet rooted in modern materials and construction, the abstracted, minimal Red Barn serves as a symbol of something lost—something people don't want to forget.

John Hill, is an architect, book author, architectural tour guide, editor (World-Architects) and blogger (A Daily Dose of Architecture) based in New York City.



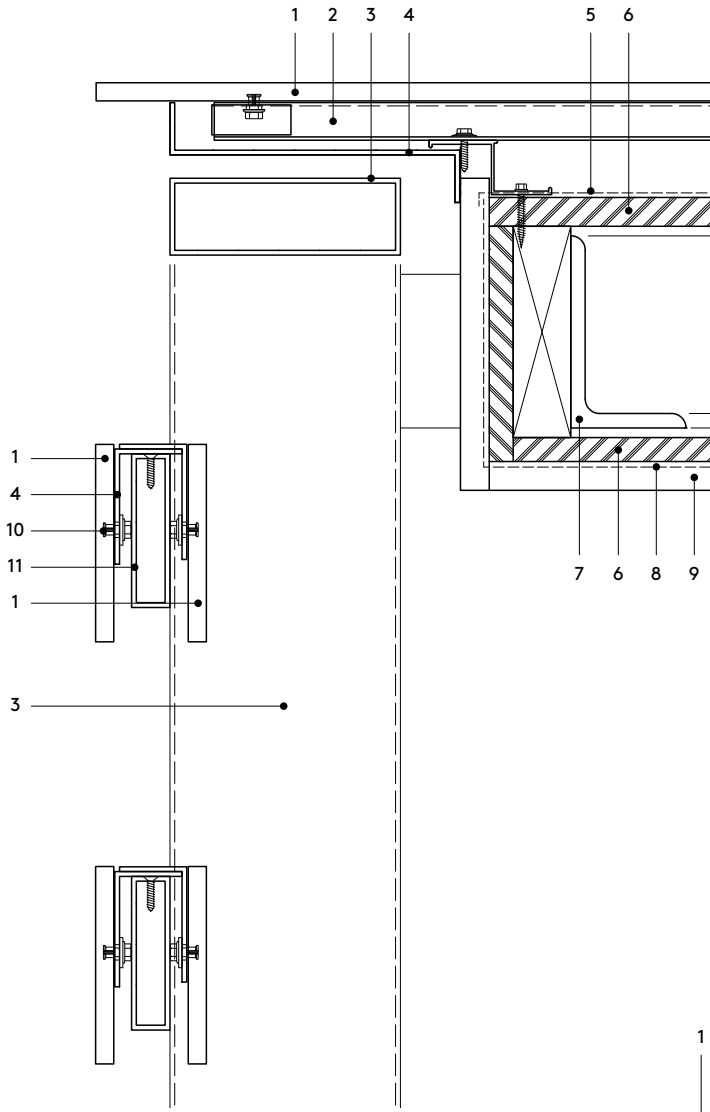

VERTICAL SECTION 1:5

- 1 Swisspearl, 12 mm
- 2 ventilation cavity, Z-girts aluminum
- 3 tube, clear anozided aluminum
- 4 angle, aluminum
- 5 waterproofing
- 6 plywood board
- 7 structural steel angle
- 8 moisture barrier
- 9 synthetic wood finish
- 10 keil undercut anchor
- 11 tube, aluminum

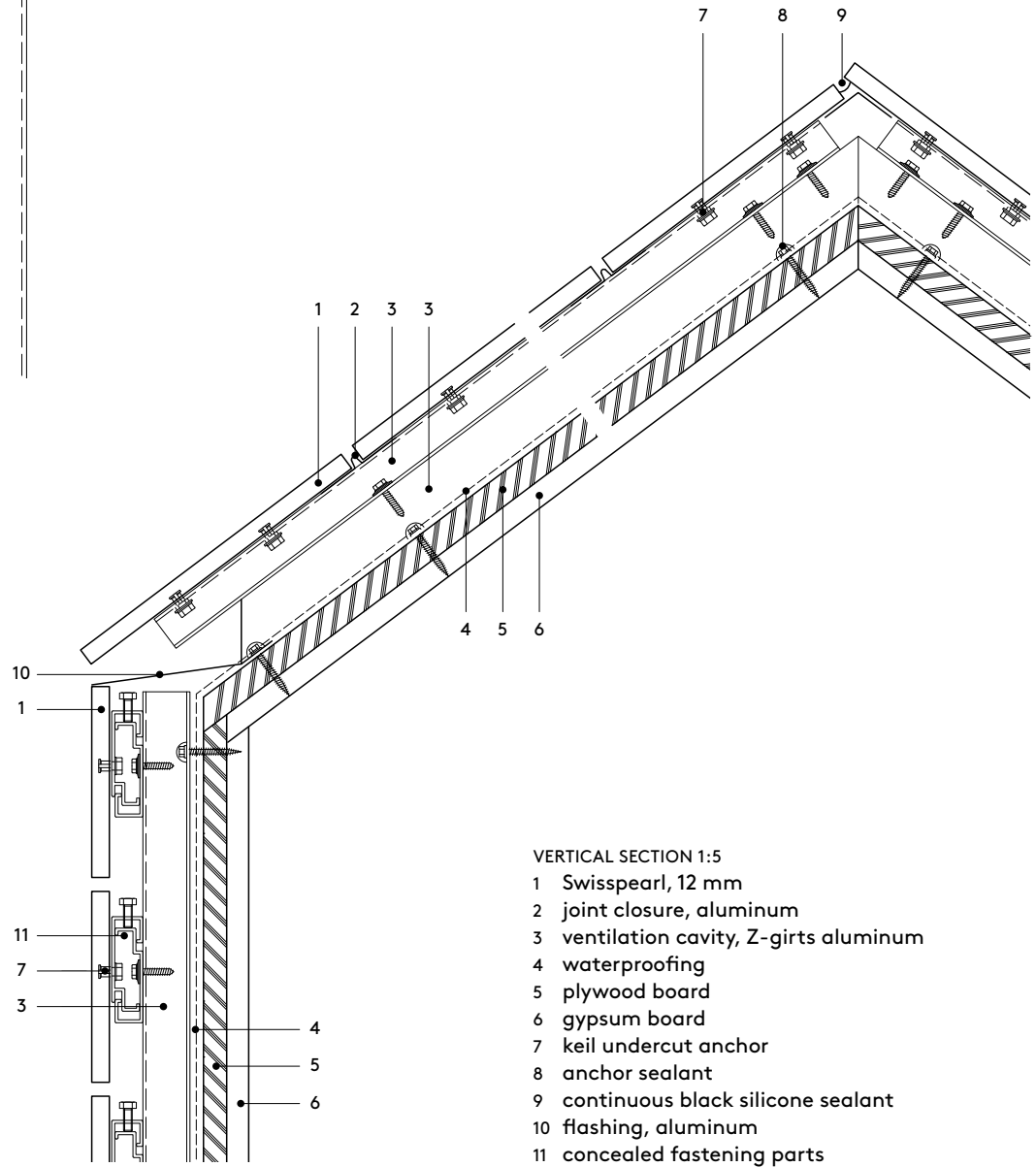

VERTICAL SECTION 1:5

- 1 Swisspearl, 12 mm
- 2 joint closure, aluminum
- 3 ventilation cavity, Z-girts aluminum
- 4 waterproofing
- 5 plywood board
- 6 gypsum board
- 7 keil undercut anchor
- 8 anchor sealant
- 9 continuous black silicone sealant
- 10 flashing, aluminum
- 11 concealed fastening parts





A color accent in the green orchard, the Red Barn is a pure abstraction of the historic typology of the New England barn.

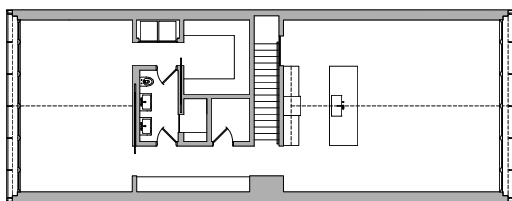
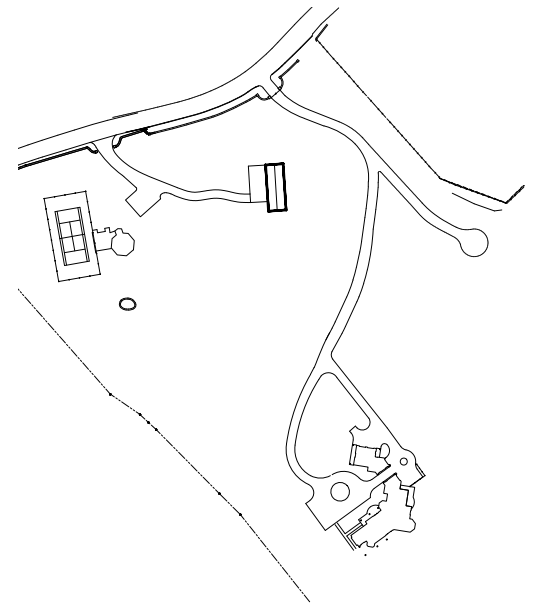
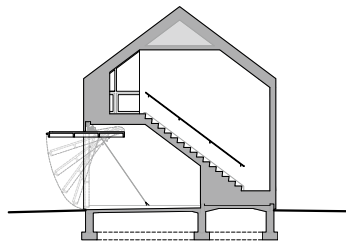
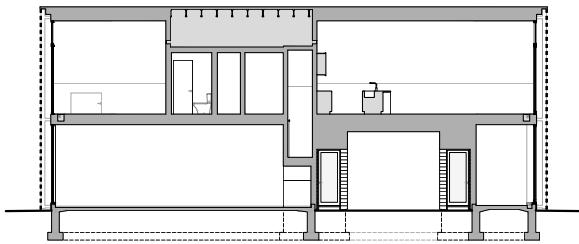

UPPER FLOOR

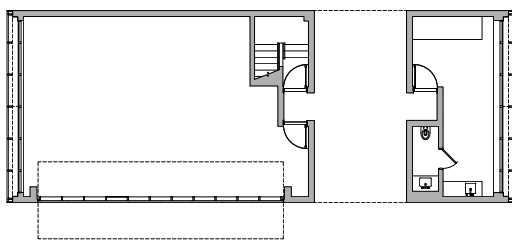

FIRST FLOOR 1:300

ADDRESS: Westport, Connecticut, USA
 CLIENT: Private
 ARCHITECTS: Roger Ferris & Partners, Westport
 BUILDING PERIOD: 2014–2016
 FAÇADE CONTRACTOR: All Panel Systems, Branford
 MATERIAL: Swisspearl Carat, Coral 7031 (R)

AWARDS: AIA Connecticut Honorable Mention, 2016; Chicago Athenaeum American Architecture Award, 2016; Architizer A+, Popular Choice Winner, 2016

INTERVIEW WITH ROGER FERRIS

“I always say we create our own challenges, we create our own struggles, our own chaos, and then try to solve it.”

Roger Ferris

Your 2016 monograph is titled *Inventive Minimalism*; how does the phrase describe your practice?

I think we add a certain level of craft and detail to our work that might be as torturous as doing historical projects. Rather than just making a simple white box, we’re striving to evidence a certain craft and meaning in what we do. So, I think that is where the title comes from: that our work is minimal, but it’s necessarily embedded with intentionality, with design idea. I always say we create our own challenges, we create our own struggles, our own chaos, and then try to solve it. The Red Barn was a very difficult thing to figure out how to build. We knew what we wanted, which was a very minimal, referential, New England red barn. In doing that, somehow it becomes more of what it is we’re trying to refrain from replicating, than if we had just done a wooden New England red

barn. There’s something about distilling it to its essence that necessarily involves a certain amount of invention. And at the same time, it appears minimal, it appears effortless, but of course it requires enormous effort.

The clubhouse you designed for The Bridge Golf Club on Long Island has blade-like forms that resemble engine parts and allude to the site’s former use as a racetrack, while the Red Barn obviously recalls its namesake. How do you develop the ideas and forms for your projects?

It’s one thing to solve problems programmatically—getting the square footage right, responding to the client’s program, responding to the site—any educated, responsible, virtuous architect can solve these problems. But there’s a point where architecture becomes, for me, something else, something more artful. Once we solve the programmatic issues then we dig deep to come up with something that is meaningful. If you’re going to go through this struggle—and architecture is a struggle for me—then you decide where you’re going to set the bar: for the building to have meaning, to be unique for the site that it’s in, and be singularly profound, poetic, lyrical. I think about our work as being like a novel. There’s an underlying theme, a main idea, and there are all these subplots that support it. In terms of our own architecture, there’s a reading of it, something that gives you a slight pause as you look at it, and somehow, it’s revealing itself, both from a distance and as you get closer to it.



So, if the plot of land you built Red Barn on was closer to the shoreline rather than the road, I'm guessing you would have designed it differently.

I wanted to situate it so you drive by and wonder, "Is that a red barn?... That's a very red barn. Why's it so red? How did they do that?" People tell me they think it's painted, but then they notice the lines, the reveals, and ask me how it's assembled. That inventive journey gives it meaning. We struggled and suffered and went through the chaos; we studied the barn, figured it out, and did it; and it became the essence of what we were after.

What is your approach to detailing and how does it manifest in the Red Barn?

We start with the idea that a building has to continue to reveal itself. We turn every corner. I am very interested in negotiating the meeting between two dissimilar materials. We need to resolve everything. I think it's in the resolution of detail that a building has a kind of craft, evidence of a kind of assemblage, a kind of human endeavor, that this was put together a certain way. Everything is as highly resolved as we can get it. It's not that

the clients ask us for that level of detail; we put that burden on ourselves. I want a building to read from a distance, to read again as you get closer, and as you sit in it I want it to continue to reveal things. We come up with a macro idea—the main plot—and then we start talking about dozens of subplots. I've challenged myself not to draw at the beginning of a project. I write short stories now, purposefully forcing myself to be more reticent from drawing. So, I had a short story about the Red Barn—about driving by, seeing it, and wondering what it is. Coming closer, it reveals more and more detail, the stuff that makes the building more than a one-liner.

Interview by John Hill



Green House



Topping Rose House

Roger Ferris & Partners

Raised in Texas, Roger Ferris moved with his family to Connecticut as a teenager, where he fortuitously met modernist architect Victor Christ-Janer. Although not widely known outside New England, Christ-Janer was influential locally, especially on Ferris. He mentored Ferris before heading off to Columbia University and then Harvard Graduate School of Design. After the Graduate School of Design, Ferris returned to Connecticut and started his eponymous office in Westport in 1988. With its main office in downtown Westport, Roger Ferris + Partners has branch offices in Manhattan and on Long Island. In addition to residential and institutional commissions in and around Westport, the firm is working on projects in Boston and Chicago.



Grove House







FOREWORD



As manufacturers, we, too, are astounded by the varied possibilities that architects and builders have found for our fiber cement products. When I look at the buildings presented, what I notice first and foremost is the diversity of possible applications. Our broad range of colors and formats is clearly being put to use.

What pleases me, personally, is the use of Swisspearl in both urban and rural areas, which I consider a key goal of our presence in the building market. In this magazine, too, I detect outstanding structures in cities and in the countryside, and also in the diverse contexts in between.

People and their well-being and satisfaction are always at the forefront for our company. This applies to both customers and employees. Our business model is built upon the interplay of people who want to create something extraordinary.

We can now look back on a successful year. Thanks to the intense cooperation with our partners, we were able to significantly increase our presence in nearly all regions of the world. I am pleased and thankful that so many architects embrace our range of products and deploy it in such diverse ways.

Marco Steg, CEO Swisspearl Group

How Are Fiber Cement Panels Created?

The technical manager explains the production process.

At the start, train cars stand ready with cement and bales of fibers. A machine processes the mixture layer by layer into panels of the desired size and thickness. However, some specific production knowledge must be considered in the manufacture of the building material. Marco Ziethen, Swisspearl's head of production technology, explains.

Several factories in Switzerland, Austria, Germany, and Slovenia manufacture Swisspearl fiber cement products. Marco Ziethen, head of production technology, guides me through the plant in Niederurnen, which has been located here in the midst of the Swiss Alps for more than 100 years. His colleague Klemens Bösch joins us at times.

In 1901, Ludwig Hatschek patented his "Procedure for the manufacture of artificial stone plates from fibrous materials and hydraulic binding agents," and registered "Eternit" as a brand name. With this, he specified the mixture of cement and fibers as well as the production process using a rotating cylindrical sieve. The inventor's goal was to produce a light, durable building panel.

The products made by this process are weather-, corrosion-, frost-, and UV-resistant, rot- and fireproof, relatively light,

and mechanically processable. While the production process has basically remained the same, it is continually optimized; today, mostly for ecological reasons. More than 90 percent of the raw materials, primarily the cement, is delivered by train from the closest factory of Holcim (Switzerland) AG in Untervaz, and roughly one-third of the products are carried away by train. The engineers are proud of the closed water circuit with two wastewater treatment plants. Water and fresh "green" fibercement waste segments are directly returned back into the production process. The hard-aggregate waste can be recycled in the cement factory and remixed with the cement. Natural gas generates the production heat required for the paint and panel drying ovens. Since 2018, the factory

has been linked up with the district heating network; surplus heat from the nearby refuse incinerator is used to heat its production halls and warehouses.

Special customer wishes—which almost exclusively concern form, color, and format of the panels—are also taken into consideration; the team gladly complies after successful feasibility studies. However, long, elaborate tests forego any changes in the composition of the material as new materials might limit the panel's function, and must be newly licensed for export, which is tied with high costs and great effort. The production specialists rule out any compromises. Product quality has top priority.

Michael Hanak



Starting material:

1. What fibers are used to produce fiber cement panels?

The main raw materials are cement, synthetic fibers, pulp, and water; color pigments are added to that. Pulp is the term used for the fibrous mass that arises during the chemical decomposition of plant fibers, which is comprised primarily of cellulose.

After the danger of inhaling asbestos became known in the 1970s a broad research program was introduced in Niederurnen to find a replacement. The first trials and initial new production took place between 1981 and 1989. Since May 1, 1990, all products for building construction from the factories in Niederurnen and Payerne have been free of asbestos. The synthetic fibers (PVA), which provide reinforcement, are from Japan. The pulp is from various countries, including Austria.



Process fibers





Synthetic fibers

Mixture

2. How and in what order are the starting materials processed and mixed?

First, bales of pulp are dissolved in water and milled to the desired fineness. This slurry is added to the pulp and synthetic fibers. The mixture is prepared in large vats in such a way that hydrogen bridges form during the chemical process, which hold the ingredients together. Finally, the cement is added in the intensive mixer. Now the setting process begins.

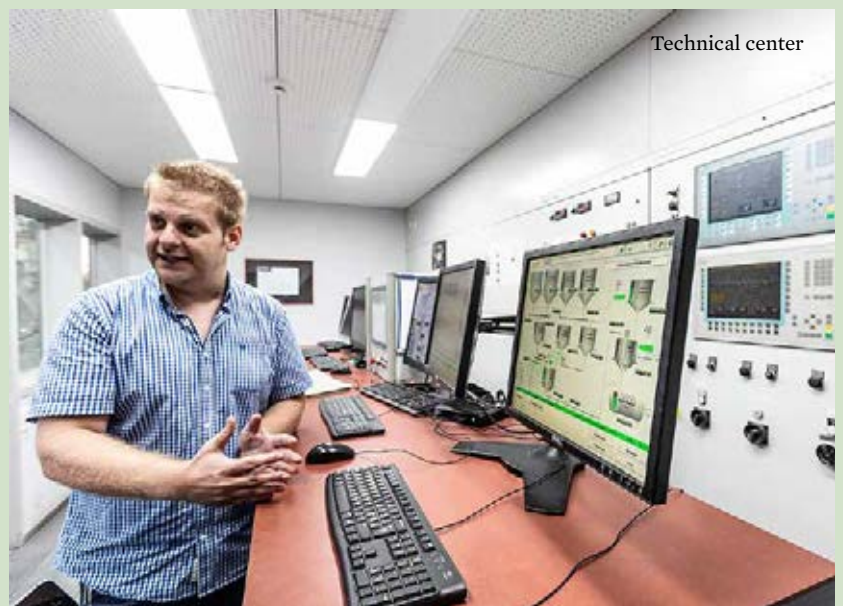

Technical center



Slurry



Format roll

Panel machines

3. How does the so-called panel machine work?

The panel machine, which was supplied by the swiss company Bell, is the heart of the production facility. Three cylindrical sieves rotate in the cement-fiber-water slurry. The rotation leads to the formation of a ca. 0.9-millimeter-thin layer, which is wound around the format roll as often as is required until the necessary thickness has been achieved. This process takes between 20 and 100 seconds, depending on the panel's dimension and format.

The diameter of the format roll determines the length of the panel, which achieves its raw format by means of an appropriate cutting blade. To produce a different format, these units have to be changed. Only experienced employees work on the panel machines. They control the measuring devices, but also use their eyes and hands.



Panel machine

Pressing and drying facility

4. How are the raw panels dried?

First, the piled-up panels are pressed under a pressure of up to 10,000 tons with steel sheets as intermediary layers, in order to release the extra water. The water content of the panels thereby is reduced from 28 to 15 percent, and the panel density is increased.

The cement continues to harden by chemical reaction with water. Heat is released during this process. The material has enough time to hydrate and solidify. After three weeks of setting, the water content remains only at 7 to 8 percent, and the panels are ready for further processing. In a first step, the panels are dried in an oven. In contrast to autoclaved fiber cement, which is steam hardened in autoclaves, air-dried fiber cement is less porous and can be processed more easily.



Panel press



Transport of a stack



Drying oven

Coating plant

5. What colors can be applied?

A standard assortment of color shades is available, which covers most customer demands. On request, however, almost any color can be applied to the panels. The standard range includes glazes and opaque colors as well as the Carat family for which the colors are applied onto panels with molded-in color. The paints are poured or sprayed onto the panels. Reflex coating offers also an iridescent series of hues with a hammer blow effect. With the Avera range, introduced three years ago, no additional color pigments are used in the coating and thus Avera shows the mass-colored fiber cement in its most natural form.



Coating line

Cut and finish

6. What formats and surface finishes are possible?

The maximum standard format that we produce is $3,070 \times 1,250$ millimeters. We are currently adapting to market demand and are increasing the standard panel width by 20 millimeters. There are five standard formats for large-format panels, from which all formats can then be cut. We are constantly in search of special surface finishes. Last year we introduced the Incora panel, which has marble granulate sprinkled in. This year, the Texial panels with a textile weave imprint are ready for production. Other exciting surface finishes are under development at the moment, but unfortunately, I'm not able to say anything about them yet.



Recipe for Eternity

Natural raw materials and enduring ingenuity shape the recipe for success for our product, which has been manufactured for more than 100 years. Thanks to our firm's long tradition, experienced employees are able to use their expertise, precision, and craftsmanship to produce the well-known building material from the preprocessed raw materials. Cement, cellulose, and reinforcing fibers combined with water form a raw mass. This is ap-

plied layer by layer to panels of the desired size. Following that, the panels are pressed, dried, and finally, dyed and cut to order. Constant quality controls assure a consistent material composition and homogeneous surfaces. After all, what distinguishes fiber cement is its recognizable texture and its equally diverse and durable coatings.

Fiber cement consists of the following five main components:

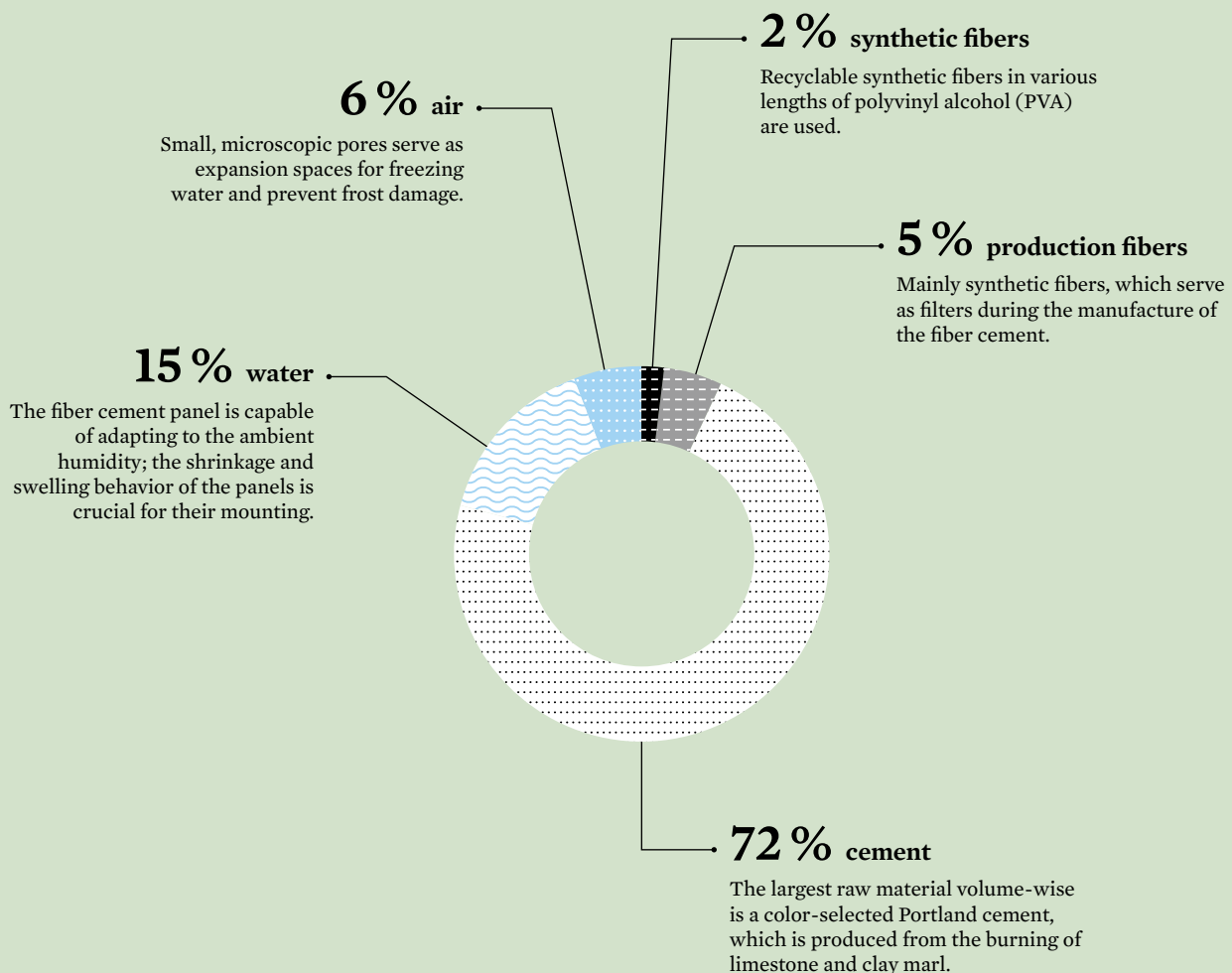



Sitting Outside: Stool G59/11

Ludwig K. Walser designed the stool for the legendary G59 horticultural exhibition while a student at the school of arts and crafts. Since the reopening of the Museum of Design Zurich, the stool has been produced as a reedition.

For the reopening of the newly renovated Museum of Design Zurich, the elegant stool G59/11 was produced as a reedition in cooperation with Eternit (Switzerland) AG. The stool is displayed on the rooftop terrace of the museum and is for sale in the museum shop.

Ludwig K. Walser (1936–2016) designed the stool, which is based on a warped cylinder, for the first Swiss Horticulture Exhibition (G59) in Zurich in 1959. The stool is representative of post-war modernism and the new garden culture that celebrated sitting outdoors.

Walser was a student at the school of arts and crafts, now Zurich University of the Arts, to which the Museum of Design has always belonged. Willy Guhl, Walser's teacher and designer of the famous loop

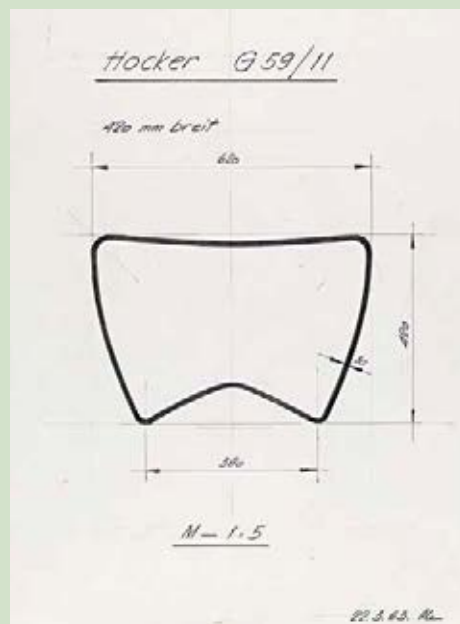

chair, participated together with his student on the competition called by the G59. Walser won second prize with his stool, which was then used at the horticultural exhibition.

After his education at the school of arts and crafts, Ludwig K. Walser made a career as a product designer. Several of his designs are part of the museum's design collection (see www.emuseum.ch). The reedition produced in the factory in Payerne corresponds with the dimensions of the original and can be identified by the engraved logo.

Renate Menzi

Design: Ludwig K. Walser, 1959
Reedition: Museum of Design Zurich/Eternit (Switzerland) AG, 2018 (www.eguide.ch)

EMPLOYEE PORTRAIT



Rahel Studer, Logistics Assistant and In-House Medic

Rahel Studer joined the Swisspearl team as a logistics apprentice four years ago. Now twenty, she continues to exercise her organizational talents from the warehouse to the office. She enjoys the variety of switching between tasks. “It’s great to do different things, instead of the same ones all the time,” she says, with obvious satisfaction.

Her newest challenge is training as an in-house emergency medical officer. The Swisspearl facility maintains a team of first responders on call around the clock. Accidents and illnesses are a reality in any workplace, but as Rahel points out, “We make sure to stay on the safe side.”

Both her older sister and her grandmother are professional paramedics, but that’s not the only family tradition Rahel is keeping up. Her grandfather, a dedicated mountaineer, passed his passion for the heights on to his three sons. Rahel began climbing with her father at the age of six. He taught her how to handle the ropes and picks, and how to read the changeable mountain weather.

More recently, she has added rock climbing and bouldering to her repertoire. During the long winter off-season, she and her friends meet at the climbing gym to socialize while they train. Between March and October, she can be found in the mountains nearly every weekend. Her favorite local destination is the Tödi, at 3,614 meters the highest peak of the nearby Glarus Alps.

As she tells it, the thrill of high altitudes and sheer rock faces can be addictive. Following in her family’s footsteps, though, she has learned to keep her balance and her nerves. Whether working as the only woman in an all-male team, handling a medical emergency, or navigating the narrowest of alpine trails, Rahel is quietly fearless. “If you panic, it’s all over. You just have to concentrate and keep going, and everything will be alright.”

Marcy Goldberg





“It’s great to live so close to the mountains. You walk out your front door and you’re practically hiking already. When you get up to 3,000 meters, though, it becomes really exciting.”



Rahel Studer on a day trip to St. Antönien and Lake Partnun in the Grisons region of Switzerland, accompanied by fellow mountain enthusiast Peter Gujan of Go Vertical GmbH.



“When I go mountain climbing,
I feel sure that none of this
was created by chance. That’s why we
must take good care of nature.”





PROFILE

Rahel Studer, age 20, works in logistics at Swisspearl and is a trainee emergency responder. She is a dedicated mountaineer and rock climber who also keeps in shape by swimming and horseback riding. To unwind, she loves to cook healthy meals.

Shaped by Hand

Twice a year, the Eternit (Switzerland) AG's factory and its molding shop in Payerne open their doors to the public. Customers have the chance to learn about the manufacture and processing of the raw materials and are able to create their own simple vessels in the molding shop.

Payerne is near Fribourg and not far from Lake Neuchâtel. The town, with its roughly 10,000 inhabitants, is known for the Swiss Air Force's military airfield, which is the largest in the country.

However, located close by the railway station is one of the fiber cement manufacturer's five factories. Not only are the well-known small-format panels produced here, but Payerne is also home to one of the firm's two molding shops. Here, individual projects are also worked on in addition to the manual serial production of planters and seating furniture.

Every object begins from exactly the same starting material as the roof and façade elements: moist panels of cement, pulp, and synthetic fibers. A felt stretched out on roles continually submerges in a basin holding the raw mixture: layer after layer, until the desired material thickness has been achieved. After all, the Austrian

Ludwig Hatschek invented the production process in 1900, and rebuilt a paper machine for this purpose. "On our machines, we can produce panels with a width of six to twelve millimeters, and that at a length of up to three meters," explains Engin Cuskun, product manager. "A natural limit is reached at a thickness of roughly fifteen millimeters, as the thicker the panels are, the heavier they are, and more difficult for the former to work with." The completed, layered panels are taken from the felt, the forms for the small-format elements punched, and then finally, pressed. The water is drained, and the binding process of the cement begins.

In contrast to this process, the starting material for the molding shop is not pressed, but instead, cut in a moist state

with corresponding stencils. The molding blanks are placed on the work bench in the neighboring hall for further processing. "With the hand-molding process, the moistness is necessary for the formability. As soon as the molding blank is cut, we have roughly two to three hours to process the material," explains Cuskun. "After that, it becomes too brittle—sure, it is possible to wet it, but the stability of the material suffers." From the molding blanks, the craftsmen shape the planters and furniture in the appropriate wooden forms. In doing so, every molding form is roughened, assembled, and condensed manually and also with a hand compressor. This is hard physical labor, both the lifting and the setting of the panels in the forms. Small tears that might possibly arise can be corrected—however deep cuts compromise the vessels' ability to withstand frost and are weak points in the statics.



Designers with whom the fiber cement manufacturer has already collaborated for a long time produce the ideas for the objects, or they arise in exchange with design schools. “Almost more important than the object itself, however, is that the necessary formwork is developed,” says Cuskun. “With some vessels, we can press the finished products out of the form with air pressure, others are opened via hinges, while others require two forms that are removed from the dried object in different directions.” The fiber cement factory develops the negative forms together with a local form builder who then produces them, while the manufacturing factory takes over the maintenance of the forms.

In this way, over the past several years new series have been steadily developed that have been integrated into the company’s regular production. But customized production is also possible—our experience ranges from lamp shades to fruit bowls through to room dividers. “With a new development, one has to consider the material qualities, whether humans can produce it, and how it is put into and taken out of the mold,” concludes Cuskun. “If the material is not overstretched, and we remain within the formats possible for human and machine, in principle, everything is possible.”

Katinka Corts



On Manufacturing Day, which is celebrated two times a year, Eternit (Schweiz) AG invites its customers to visit the factory and the molding shop. In addition to a guided tour, visitors can also try their hand at producing their own simple vessels.



One of the currently five total production locations of the Swisspearl Group is in Payerne, in western Switzerland. Payerne is home to one of the two molding shops where planters, seating furniture, as well as molded pieces for roof weathering, among other items, are molded manually. At the locations in Austria and Germany, mainly façade and roof panels are manufactured. The factory in Slovenia produces primarily corrugated panels and molded parts.

SHORT MESSAGES



AIA 2018 NYC

It was the architecture and design event of the year! Within the framework of the official exhibition motto “Blueprint for Better Cities,” Swisspearl presented their aesthetic, sustainably produced, and long-lasting fiber cement panels at the 2018 Architecture Expo in New York City, which took place parallel to the AIA Conference on Architecture 2018. Swisspearl was pleased to be invited to take part in the fair once again and we completely redesigned our booth design, creating a prime showcase for our high-quality fiber cement products. The new design utilizes clean lines and modern flair, which allows us to optimally highlight our products. In the end, the AIA turned out to be an amazing exhibition for Swisspearl and all of our partners! Our brand new booth and products combined with the fantastic team, made this show an extraordinary event.

conferenceonarchitecture.com

Design Versatility With StoPanel

The Atlanta based firm Sto Corp., world leader in cladding, air barriers, panelization, coatings, and restoration solutions, recently announced that the company’s prefabrication division, StoPanel Technology, is now partnered with Swisspearl, the inventors of fiber cement panels. The two companies have teamed up to offer a continuous insulation system that uniquely combines the convenience and cost-effectiveness of offsite panel manufacturing with the look and feel of an innovative, contemporary aesthetic. The inclusion of Swisspearl in the StoPanel line-up of prefabricated panel options provides owners and design professionals with a wide range of attractive fiber cement panel and color options along with the benefits provided when using a cladding that offers a rainscreen design.

www.stocorp.com



Texial, Unique Through Hand Embossing



Innovative and sustainable products made of natural raw materials, such as the new large size façade panels Texial, are born of ingenuity and expertise. The fine surface structure has the appearance of a fabric and hand-embossing makes it consistently unique. Delicate nuances of color and the raw texture resulting from the mechanical embossing process highlight the authenticity of the work. A vibrant interplay of light

and shadow creates a dynamic effect, making the façades appear almost like a piece of cloth.

Texial is available in five colors. While the earth tones blend seamlessly into their environment, at the same time, they also make an impact because of their timeless nature. The natural, harmonic color spectrum underscores the character of Texial.

blog.swisspearl.com

SELECTED BUILDINGS

Every year, a great number of building projects are carried out with Swisspearl. On the following pages, we present 14 particularly remarkable buildings.

In today's architecture, building forms are the result of various influences. The urban planning context and the available property play just as much a role as alignment with the sun.

Architects seek to satisfy the complex conditions with multiform building volumes. For the composition and arrangement of the buildings they gladly combine diverse materials.

The specific look and feel of the building materials, the different surfaces and colors, help to distinguish the buildings.

In this year's selection, it becomes evident that different size panels and joints are used to clad multiform, polygonal building volumes.

They are often combined with other building materials, such as wood, metal, brick, or natural stone. The material combinations provide structure, contrast, and variety.

What can also be observed are the calm building shells that arise through uniform colors, formats, and the visual convergence of façade and roof.



Enlarged and Enhanced

House Extension Black Box II, Montreal, Canada

Black Box II is the latest in a series of micro-additions that significantly impact existing buildings. Conceived as a giant jewelry box, large openings blur the boundary between interior and exterior, revealing its treasure of fine craftsmanship through the playful use of complementary surface materials.

This semi-detached, red clay brick townhouse is typical of the architecture of Westmount and the Notre-Dame-de-Grâce borough of Montreal. Through the reconfiguration of outdated internal divisions and the grafting of two black volumes juxtaposed with the masonry, the pre-existing architecture is enhanced and transformed to better reflect the modern lifestyle and aspirations of its inhabitants.

The Black Box II addition to the existing masonry house is clad in large-format, black Swisspearl fiber cement panels finely assembled with matching rivets. The balustrade of the loggia is a single, large perforated Swisspearl panel. In contrast, ochre-colored wood and light ceramics embellish the interior. Large windows fold open to incorporate the garden into the home, and interior and exterior materials interact to connect the various spaces. Inside, walls and ceiling are clad in oak wood paneling, while the exterior alcove is clad in horizontal bands of western red cedar. The

slate slab stones of the terrace contrast strongly with the fine ceramic of the kitchen floor. Incorporating the heritage of the past, the original oak floor of the dining room was preserved and restored, setting the tone for the interiors. The solid oak kitchen island demarcates the open plan kitchen and dining spaces, standing as a kind of altar to daily rituals. More sober, white and black furniture and cabinetry are situated at the perimeter.

This project is an excellent example of architecture that recognizes the collaboration between the architect, the builders, and the owners, all actively involved in the search for quality, both technical and aesthetic. The art of architecture manifests itself here in all its dimensions. We always strive to strike the right balance between new and old in order to create a coherent whole, preserving the authenticity of the existing details, while affirming the contemporary spirit of our interventions.

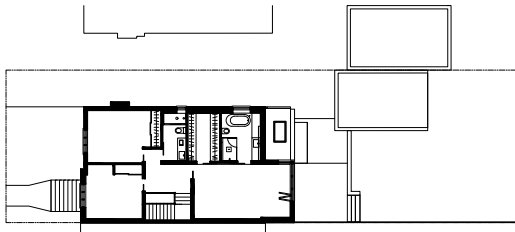

UPPER FLOOR

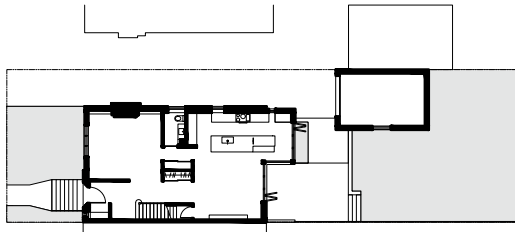

FIRST FLOOR 1:500





In the main bedroom, large concertina doors open up to the rear garden. A perforated balustrade affords privacy.



A bold juxtaposition of russet textured masonry offsets the smooth surfaces of black panels, which demarcates Natalie Dionne's micro extension.

LOCATION: 4707 Avenue Roslyn, Montreal, Canada
CLIENT: Miguel Cobo, Montreal
ARCHITECTS: Natalie Dionne Architecture,
Montreal; Natalie Dionne, Martin Laneuville,
Ariane Côté-Bélisle, Corinne Deleers
BUILDING PERIOD: 2017
GENERAL CONTRACTOR AND FAÇADE CONSTRUCTION:
Pierre Aubin P. A. Construction, Montreal
FAÇADE MATERIAL: Swisspearl Reflex, Black Velvet
9221 (both sides coated and perforated)





Stacking and Shifting Planes

Residential Building Salaino 10, Milan, Italy

The brief for this project in Milan called for the urban renewal of the area and the renovation and conversion of the building for residential use. Sliding, screen-printed glass panels and black Swisspearl panels on the façades create a dynamic pattern of shifting planes held between the horizontal concrete floor slabs.

The total reconfiguration of the volumes was made possible by the autonomous character of the construction, which is now a freestanding building within a garden, enclosed by a transparent screen toward the park, thus creating the perception of a single green zone continuous with Solari Park. The main entrance on Via Salaino is a low volume that reflects the footprint and profile of the existing building and controls vehicular access, while permitting pedestrian access sheltered by a pergola with planting and access to the underground garage, cellars, and technical spaces. The building is structured around a series of patios and raised gardens that transform its horizontal levels into green spaces. The street façade has been treated with decorative concrete, textured and patterned with perforations that evoke the motifs of the finest buildings in the neighborhood.

The primary volume raises eight levels above ground, while the loft apartments are aligned with the height of the adjacent build-

ings. Antonio Citterio and Patricia Viel completely redesigned the elevation, creating a façade with a double skin with a shifting pattern of golden bronze-tone, screen-printed glass panels that protect the loggias and a continuous balcony along the entire perimeter of the building on every level. Textile sunscreens are inserted to protect the entire volume from the harsh sun. The detail of the continuous balcony accentuates the layered composition of the volume, emphasizing the metal profiles; the glass/textile exterior skin protects and conceals the perforated internal façade, which is clad in black Swisspearl panels.

The aim is to offer a building with a contemporary language that expresses its residential character through the apparently random composition of decorated glass panels and white fabric, while at the same time creating layers of privacy provided by the set-backs in the façades and the protective screening.

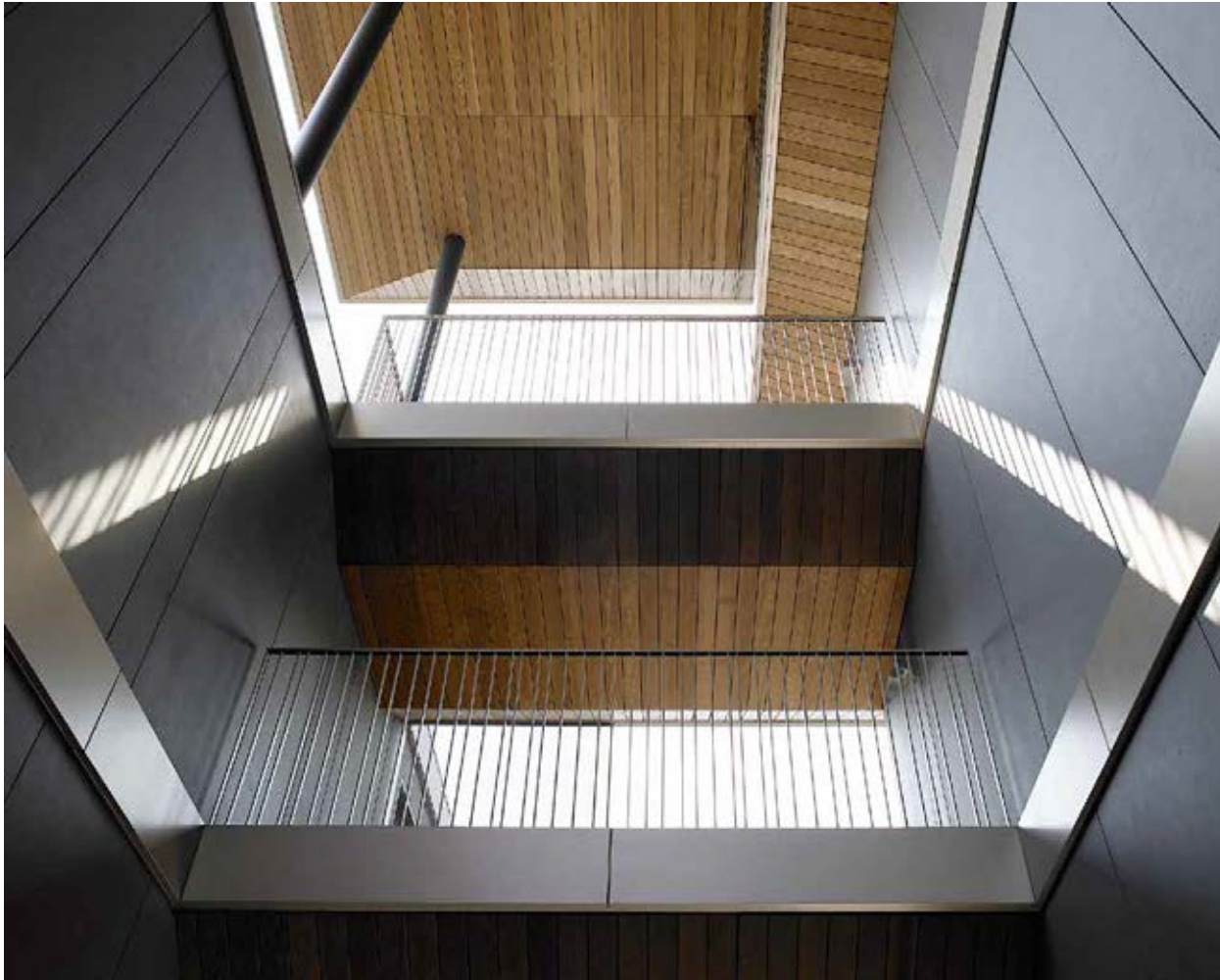

The detail of the continuous balconies accentuates the layered composition of the volume and conceals the perforated internal façade, which is clad in Black Velvet Swisspearl panels.



LOCATION: Via Salaino 10, Milan, Italy
 CLIENT: Dolce Vita Salaino 10 S.r.l., Milan
 ARCHITECTS: Antonio Citterio Patricia Viel, Milan
 BUILDING PERIOD: 2011
 GENERAL CONTRACTOR AND FAÇADE CONSTRUCTION: GDM
 Costruzioni S.p.a., Offanengo
 FAÇADE MATERIAL: Swisspearl Reflex, Black Velvet 9221
 (perforated)

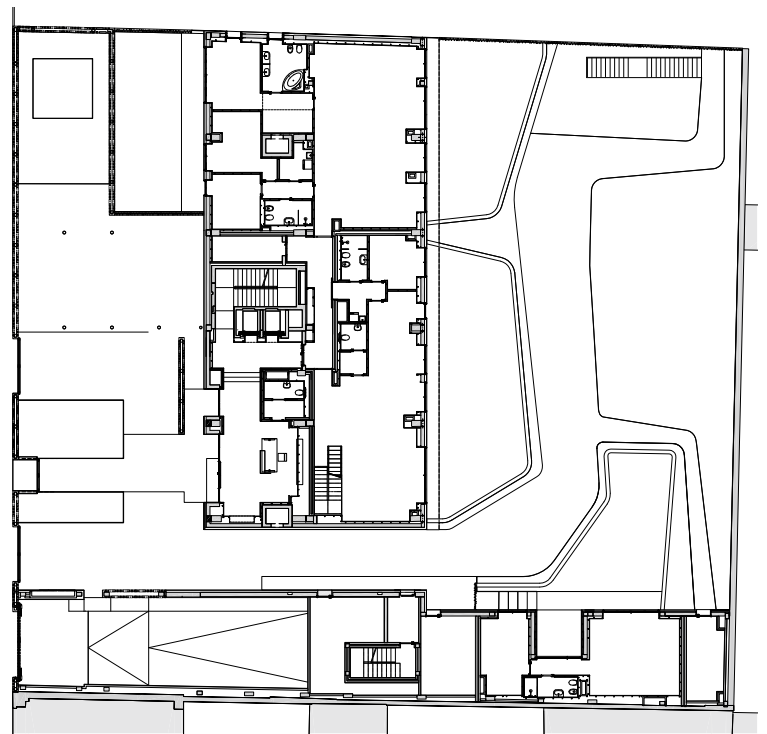
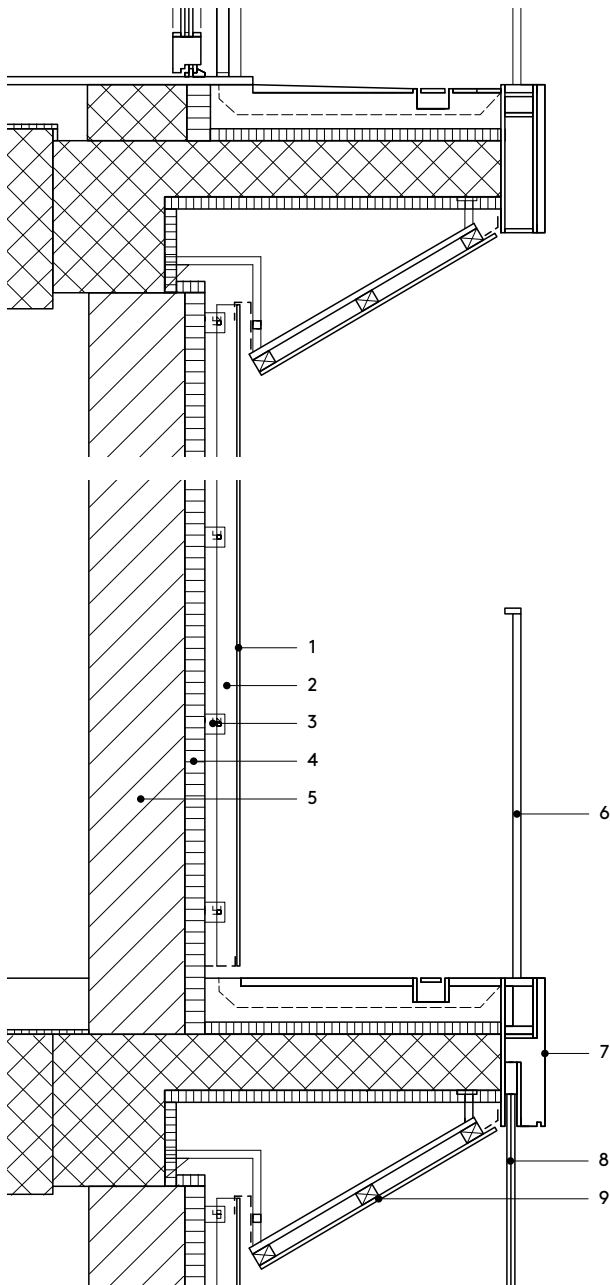
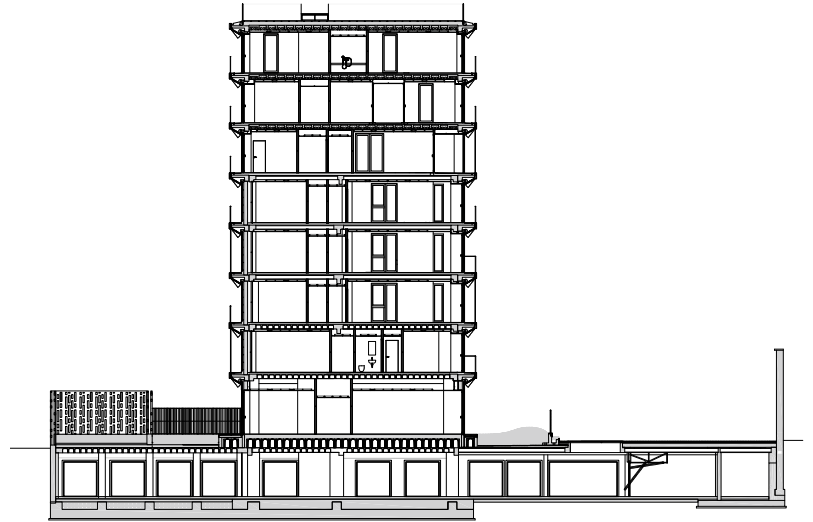

FIRST FLOOR 1:500

VERTICAL SECTION 1:20

- 1 Swisspearl, 8 mm
- 2 ventilation cavity, vertical sub framing
- 3 sub framing
- 4 thermal insulation
- 5 infill wall in autoclaved areated concrete blocks
- 6 balustrade
- 7 steel sheet
- 8 glazing
- 9 suspended ceiling, ash wood

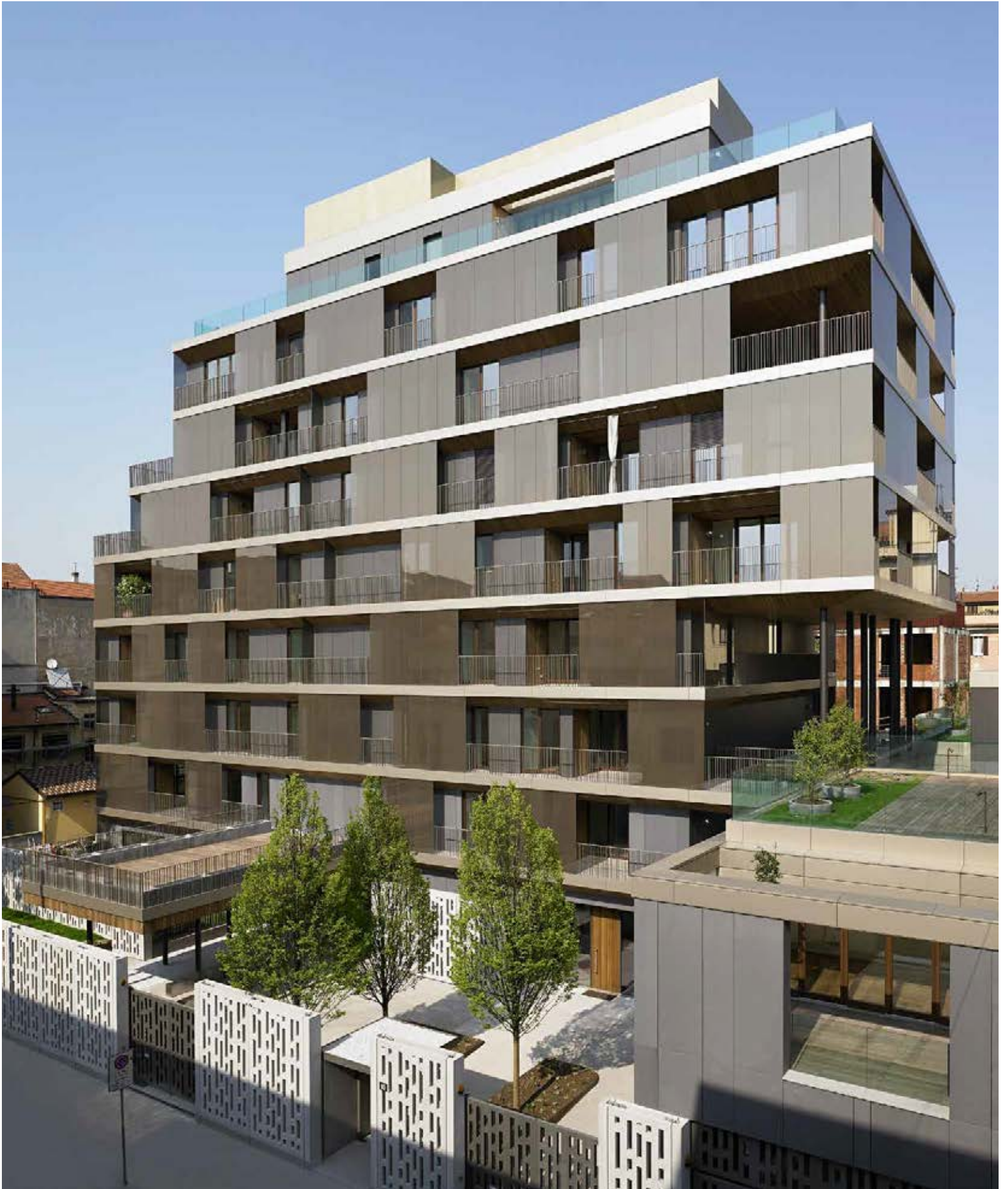



City Living on the Lake

Aurora Buildings, Canberra, Australia

The Aurora precinct in Canberra is a sustainable, mixed-use scheme consisting of high-quality apartments, restaurants, and office spaces within the Kingston Foreshore precinct on Lake Burley Griffin. Quality urban architecture and sustainability were primary aims for both the client and the architect.

Cox Architecture has been involved with the precinct since the adoption of the master plan in 1997 and occupies the first and second floor of the commercial spaces in Aurora. The buildings consist of six-story, concrete-framed structures clad in grey Swisspearl panels, natural zinc and glass. The grey façades are visually cool elements in the hot Australian climate. With direct northern frontage to Lake Burley Griffin, Aurora has been designed to deliver a simple, yet bold scheme responding to the complex site requirements and the surrounding environment. The design optimizes the adjacent promenade and lake views, with the built forms making way to create an inner courtyard with a protected northerly aspect. Glazed balconies project out towards the lake promenade. The stripped back interior exposes the “real” building and mentally challenges the prevailing office fit-out.

Early in the design process, the client expressed a willingness to exceed the minimum

code requirements for the mixed-use development of the site. Already at an early stage, a decision was made to incorporate sustainable elements, such as: increased thermal insulation, the use of high performance glazing and sun-shading elements, northern orientation, photo voltaic cells, underground garage with installations for electrical cars, and air exchange units for residential apartments. Thanks to these measures, all residential units achieved a minimum 6-star rating, with the building average 7.5 stars. In response to poor indoor air quality within residential apartments in a cool climate, air exchange units were also incorporated. These units supplement natural (non-conditioned) air ventilation within the apartment. Aurora demonstrates that architecture is about developing integrated, creative, cost effective and innovative solutions that incorporate the latest technology to enable flexible work practice.

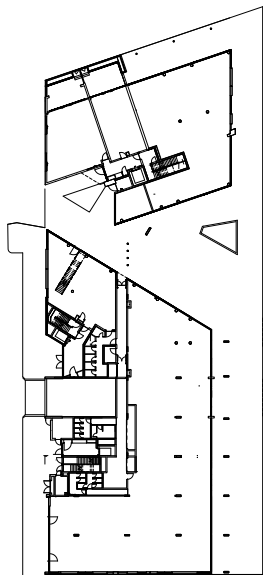

FIRST FLOOR 1:1000

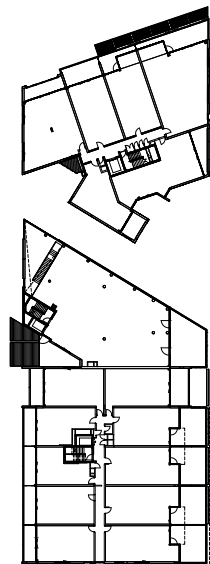

SECOND FLOOR

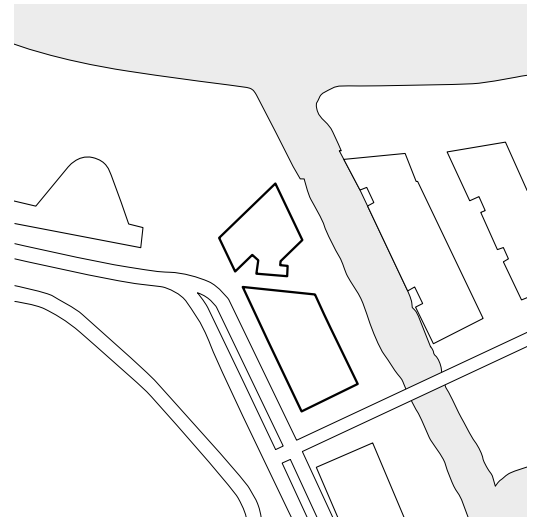

LOCATION: 17 Eastlake Parade, Kingston, Canberra, Australia

CLIENT: Englobo Group, Braddon

ARCHITECTS: Cox Architecture, Sydney

BUILDING PERIOD: 2011–2012

GENERAL CONTRACTOR: Building Coordination, Deakin

FAÇADE CONSTRUCTION: Hi-Tec, Arndell Park

FAÇADE MATERIAL: Swisspearl Carat, Sapphire 7060

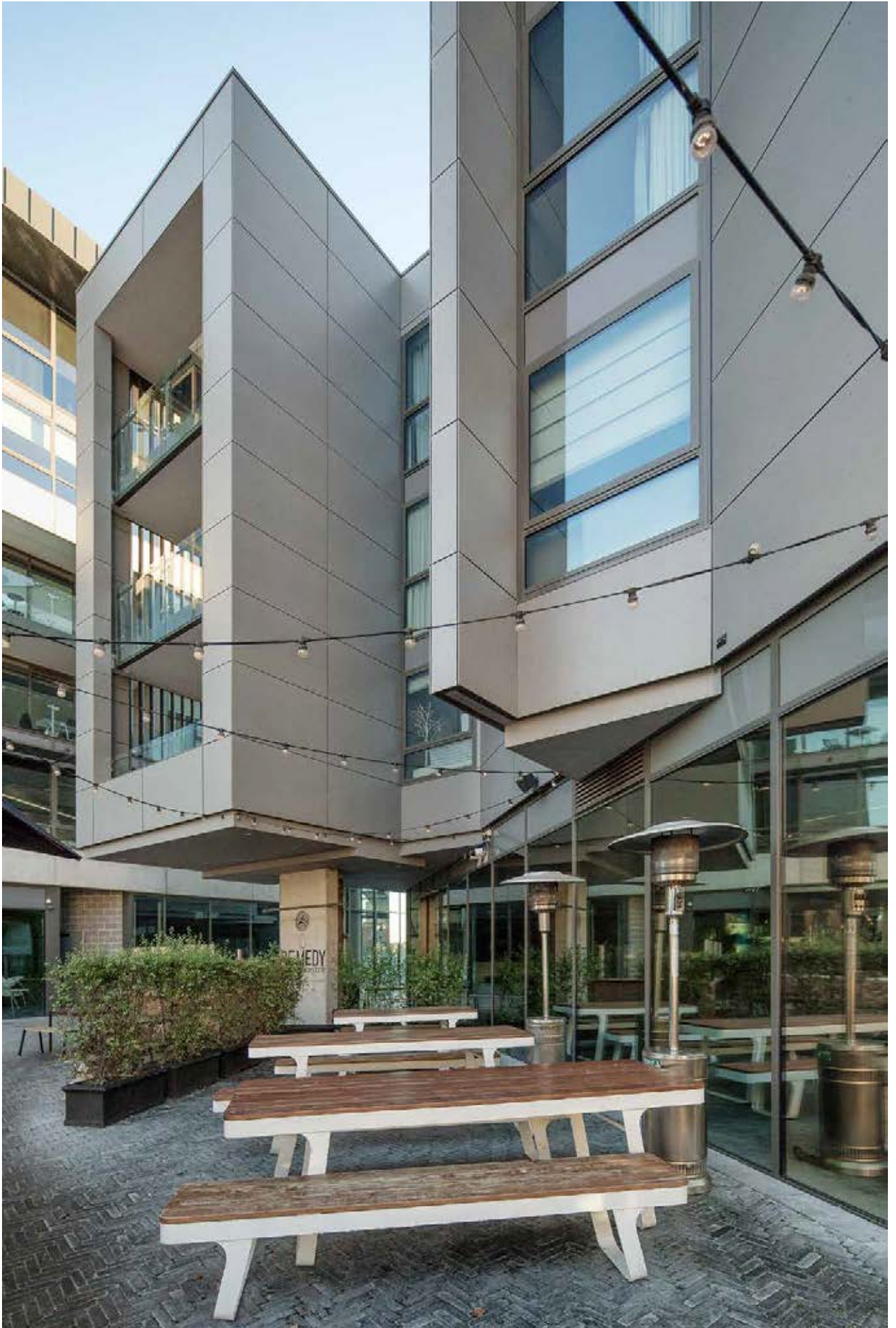



WHITE ARKITEKTER

A Science Hub

Laboratories and Office Building Hubben,
Uppsala, Sweden

Uppsala Science Park is ranked as one of the world's best corporate incubators and is known far beyond the borders of Sweden. Innovative ideas about life science, biotechnology, medicine, and IT are researched and developed here.

With 17,000 square meters distributed across five floors, the rectilinear building expresses its prominent status by its scale, proportioning, and materialization. A broad façade clad in light grey horizontal and vertical panels is offset by a patchwork collage of diamond-shaped Swisspearl panels in shades of russet reds, oranges, and ochers. The autumnal color palette and the intense rhythm of window openings is a reference to the adjacent historical buildings. A generous square opens to the south and is a popular meeting place for researchers, innovators, and entrepreneurs who work in the park. Interestingly, the project was completed

around eight percent below budget and on schedule. Furthermore, it was awarded a LEED-Platinum certification and is exemplary for its high degree of prefabrication and use of digital technologies. One of the most important aspects of the design is flexibility; this allows for the allocation of different floor plan solutions for different kinds of tenants and the combining of laboratories and offices on the same floor level. A highly complex array of technical systems above the ceiling is required and the wall and floor constructions have to be easily modifiable to accommodate this high level of flexibility.

VERTICAL SECTION 1:10

- 1 Swisspearl, 12 mm
- 2 steel angle
- 3 stainless steel plate
- 4 ventilation cavity, vertical sub framing
- 5 horizontal sub framing
- 6 thermal insulation
- 7 insect screen
- 8 steel tube
- 9 waterproof board
- 10 in-situ concrete
- 11 waterproofing
- 12 prefabricated concrete
- 13 ventilation channel isolaton

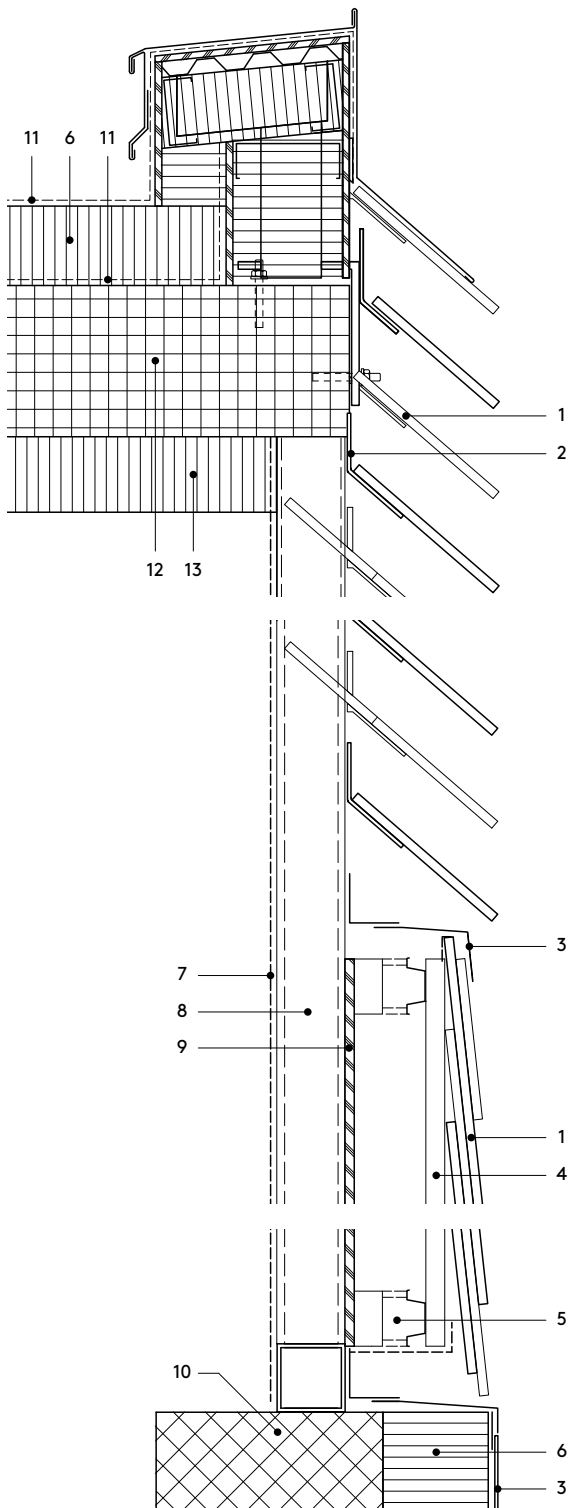

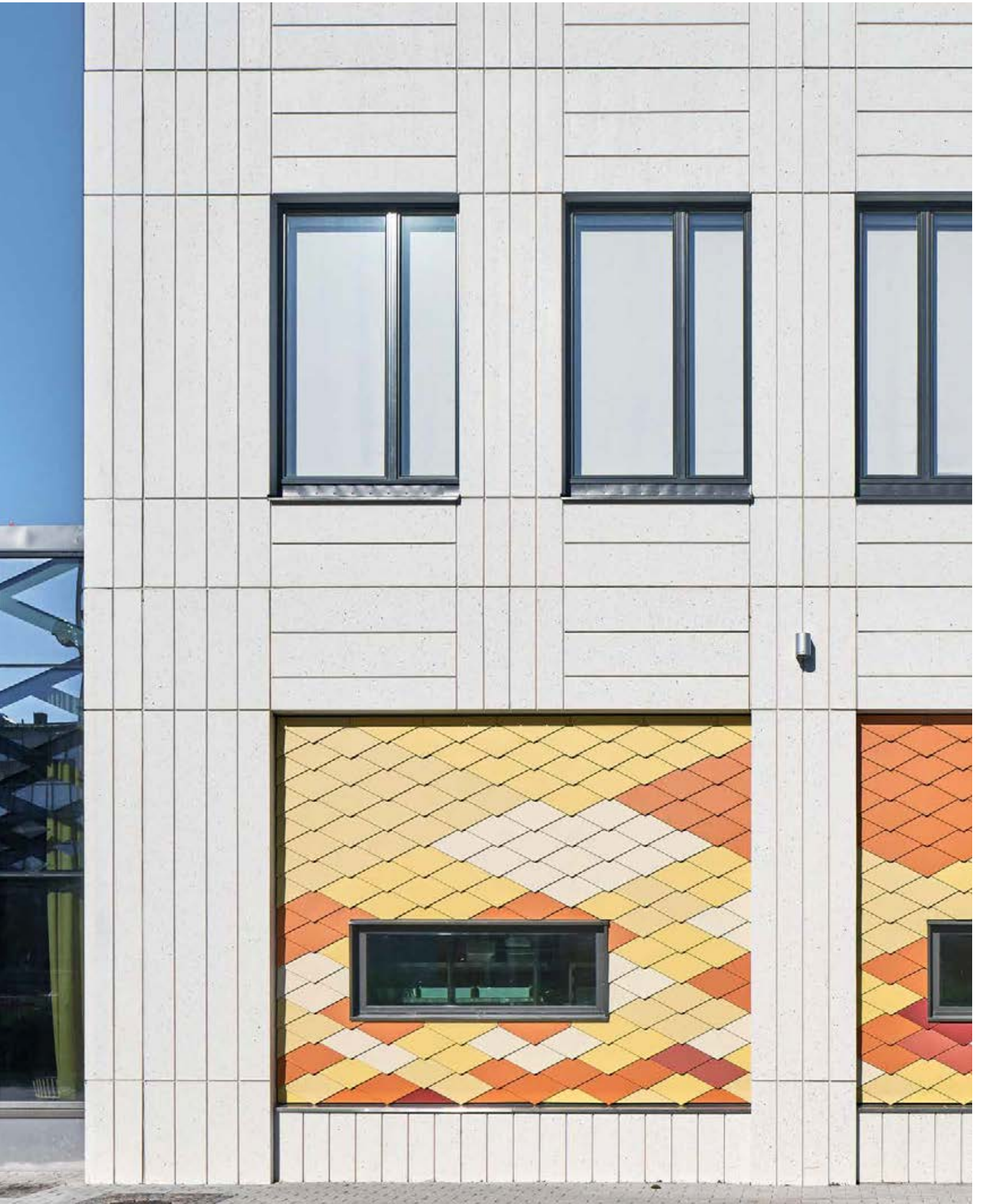

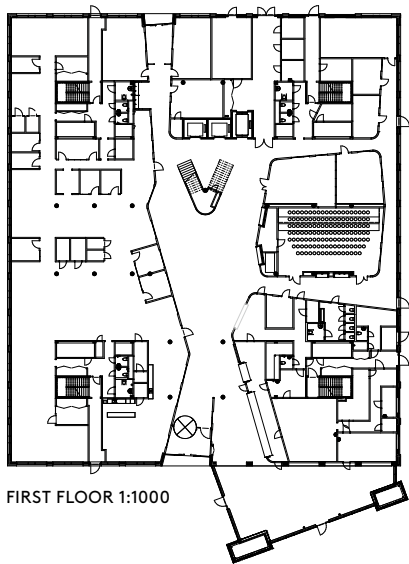

FIRST FLOOR 1:1000

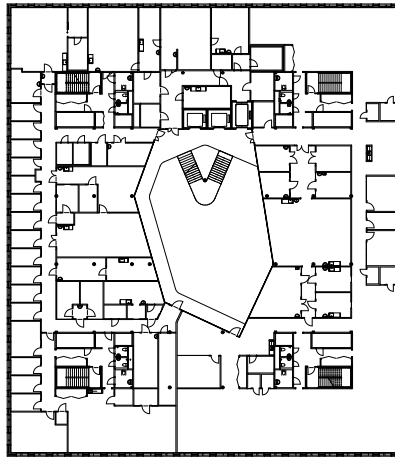

SECOND FLOOR

Diamond-shaped tiles of fiber cement, like multi-colored shingles, were used in the attic and the ventilation tower, as well as in the interior.

LOCATION: Dag Hammarskjölds väg 38, Uppsala, Sweden
 CLIENT: Vasakronan, Stockholm
 ARCHITECTS: White Arkitekter AB, Uppsala
 BUILDING PERIOD: 2016–2017
 GENERAL CONTRACTOR AND FAÇADE CONSTRUCTION:
 Byggstyrning i Norden AB, Uppsala
 FAÇADE CONSTRUCTION: ÅC Bygg AB, Knivsta
 FAÇADE MATERIAL: Swisspearl Carat, Coral 7031, 7032 and
 7033, Topaz 7071 and 7073, Amber 7081, 7082, and 7083







Two Boxes Stacked Aloft

Tartu University Hospital Extension,
Tartu, Estonia

Tartu University Hospital Extension includes three new expandable units for the hospital complex, which was built over a number of decades. Two new units, the children's hospital and outpatient surgery, are accommodated in the extension of this clinic.

The various buildings designed and built in their time, showcase a variety of architectural styles and materials. This project is a continuation of the previous attempt to combine existing architectural elements and create a harmonious whole. The extension is designed with a lofty, triple-volume atrium between the two so-called "towers." One of the main concepts was to create a long gallery to the rear of the building to ease the logistics of the entire hospital complex. The linear accelerators for the radiotherapy department are situated beneath the atrium on the basement floor. All personnel circulation, as well as material flow for the hospital has been placed in a new "internal street" between two, eight-story wings. The new buildings include facilities designed for cardi-

ology, ophthalmology, internal medicine, endoscopy, hospital pharmacy, laboratories, as well as a new radiotherapy department. New wards accommodate around 260 beds. Furthermore, all wards have teaching facilities for the University of Tartu Faculty of Medicine.

AW2's intervention has received positive feedback from patients at the Tartu University Hospital. A parent of one of the patients wrote: "I was in hospital with my child and I'd like to say that this building is architecturally beautiful. The views of the inner corridors, lobby, and the hall were very calming and healing with lots of palm trees. We walked around the building every day. Thank you once again for a pleasant hospital experience!"





VERTICAL SECTION 1:20

- 1 Swisspearl, 12 mm
- 2 concealed fastening parts
- 3 ventilation cavity, vertical sub framing
- 4 wind stop board
- 5 thermal insulation
- 6 concrete
- 7 waterproofing
- 8 insulation board
- 9 concrete hollow-core slab
- 10 steel frame for suspended ceiling
- 11 suspended ceiling

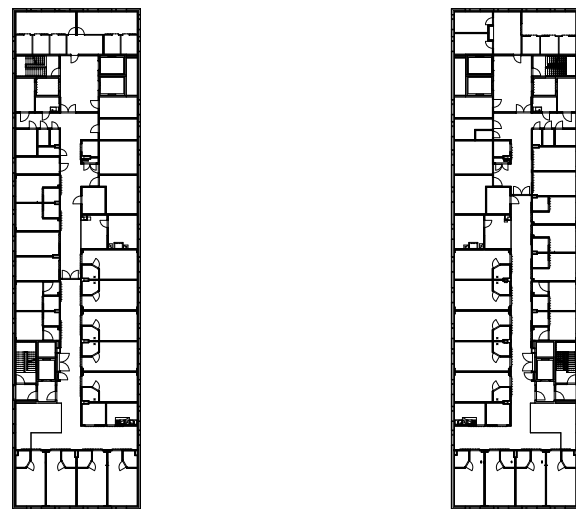
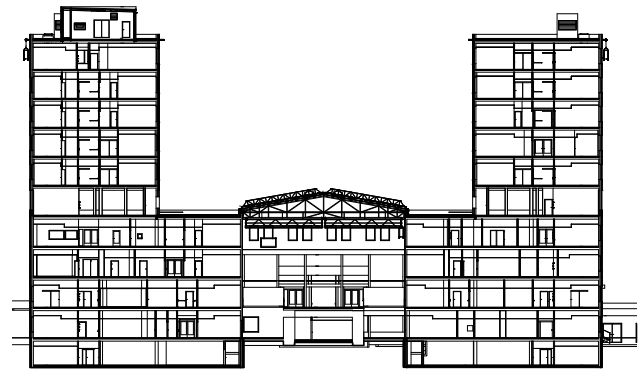
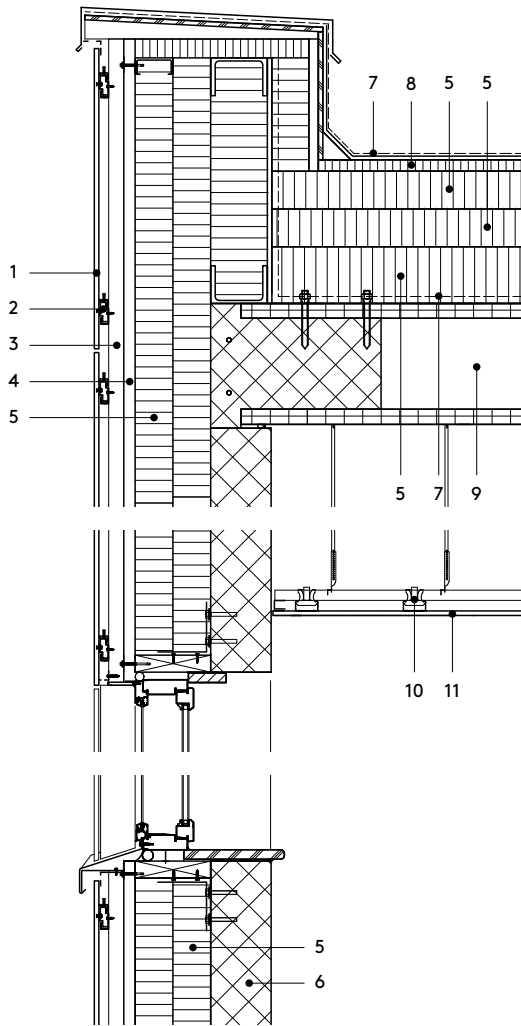

SEVENTH FLOOR

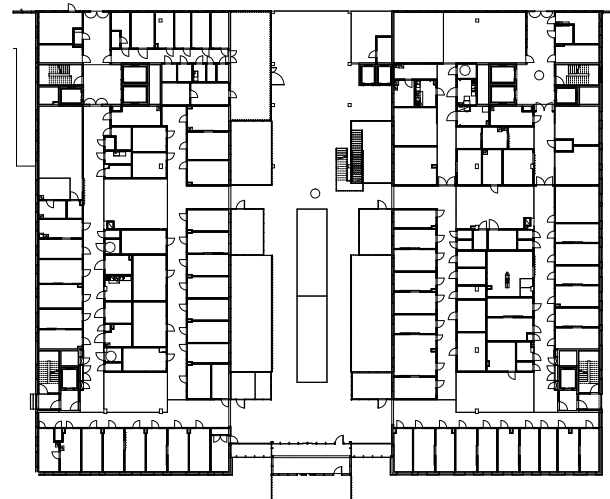

FIRST FLOOR 1:1000

LOCATION: Ludvig Puusepa 8, Tartu, Estonia
CLIENT: Tartu University Clinic
ARCHITECTS: AW2 Architects, Helsinki
BUILDING PERIOD: 2012–2015
GENERAL CONTRACTOR: Rand & Tuulberg AS, Tartu, Estland
FAÇADE CONSTRUCTION: Astlanda Ehitus OÜ, Tallinn
FAÇADE MATERIAL: Swisspearl Carat, Jade 7052 and Onyx 7099



All personnel circulation as well as material flow for the hospital has been placed in a new, day-lit "internal street" between two eight-story wings.



A Treasury of Learning Nestled in Nature

Varina Area Library, Richmond, USA

Varina Area Library is envisioned as a place for individual transformation and community advancement, as well as a learning hub. Situated in an agrarian part of Henrico County along the historic State Route 5, the new library connects Virginia's historic capital in Williamsburg to its current capital in Richmond.

The twenty-two-acre site offers opportunities to connect library patrons with the rural/agrarian context in historic and contemporary ways. A large portion of the site slopes to the south and west toward a perennial stream and wetlands that are protected from development. To take advantage of the pleasant views of this natural habitat, the library is situated at the top of the slope, adjacent to a level section of the site that had been previously cleared and farmed. Parking was kept away from the library as far as possible, thereby creating a generous area for public gatherings and community events.

BCWH embraced the idea that the library should reflect and reinforce the unique character of the local culture. Thus, the library is rooted in its natural environment as much as it is rooted in the community. Configured as a series of pavilions emerging from and cascading down the landscape, the forms of the pavilions

reflect the community's vernacular architectural heritage, being vaguely reminiscent of a collection of tobacco barns. A varied palette of building materials on the interiors and the exteriors reinforces this concept. Stone retainers, steel sheet cladding, and deep russet red Swisspearl panels create a collage of surface textures and colors.

The terrain between the primary pavilions cascades from the entry level down the slope of the site to the woodlands. This area is connected to the Children's Collection as well as the Community Gathering areas. This "in-between" space is employed to enhance local networking by providing space for ad hoc encounters on the seating steps, at the intermediate terrace, the café, and the lower terrace. Further enhancing community connectivity, the lofty space occasionally serves as a venue for viewing movies, with a retractable cinema-size projection screen.

LOCATION: 1875 New Market Road, Richmond, USA
 CLIENT: Henrico County Public Library, Richmond
 ARCHITECTS: BCWH Architecture, Richmond, and
 Tappé Architects, Boston
 BUILDING PERIOD: 2015–2016
 FAÇADE CONSTRUCTION: Roof Systems of VA, Richmond
 FAÇADE MATERIAL: Swisspearl Carat, Coral 7030



UPPER FLOOR

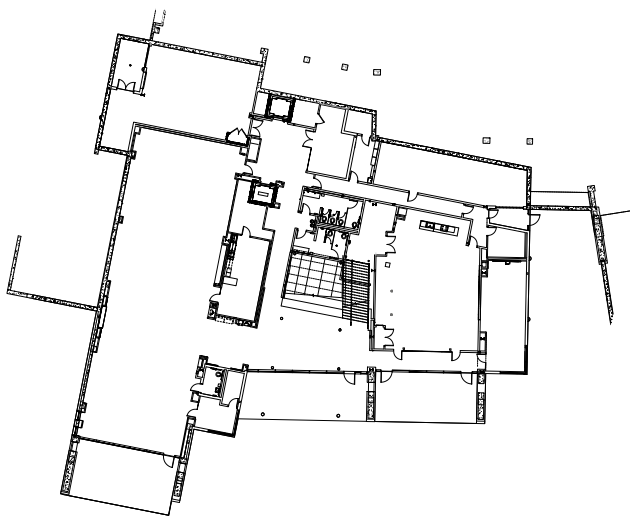

FIRST FLOOR 1:1000

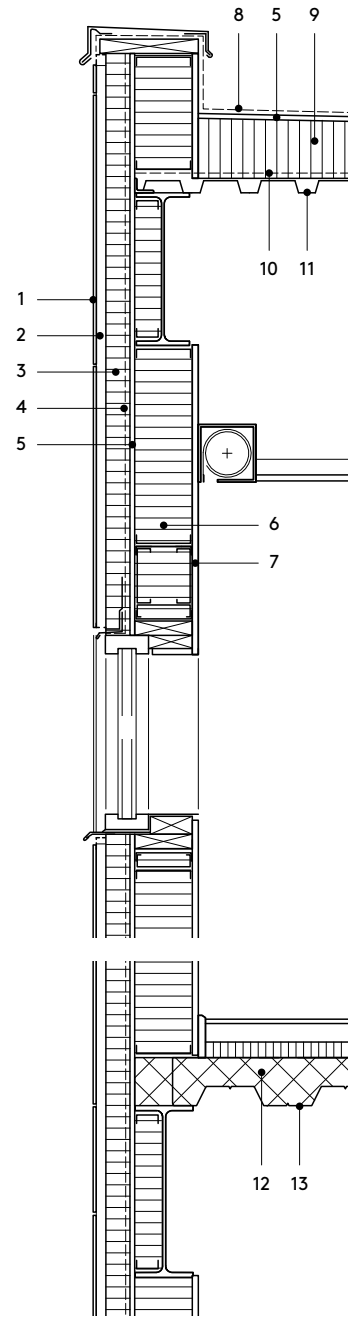

VERTICAL SECTION 1:20

- 1 Swisspearl, 8 mm
- 2 ventilation cavity, vertical sub framing
- 3 thermal insulation, mineral wool with black scrim facing
- 4 moisture barrier
- 5 building board
- 6 thermal insulation
- 7 gypsum board
- 8 waterproofing
- 9 thermal insulation, rigid
- 10 vapor retarder
- 11 metal deck
- 12 composite slab
- 13 gage galvanized composite deck



Configured as a series of pavilions emerging from and cascading down the landscape, the forms of the pavilions reflect the community's vernacular architectural heritage.





XL Villa for an XL Family

House XL, Leskovec pri Krškem, Slovenia

Designed for a large family of seven, House XL is located on the outskirts of a new residential area in the east of Slovenia. SoNo Architects' design takes its cue from the typically Slovenian architectural elements and the rolling hills and fields surrounding it.

The house consists of three, double-pitch, gable-roofed volumes: two of which are perpendicular and run parallel to one another, thereby creating a sheltered outdoor living and eating space between them. In essence, SoNo architects' design is a modern interpretation of a rural barn.

While the basement level, where the laundry, storage, and technical spaces are located, is constructed from reinforced steel, the upper floors consist entirely of cross-laminated timber elements. Organized on three levels, the floor plan layout is light and spacious. All the communal areas, like the open plan kitchen and dining area with study are situated on the ground level in the northern wing and the living areas are situated in the southern wing, which extends to create a covered carport. With its large, glazed sliding doors, the living area opens to the atrium, thus maintaining an

intimate relationship between the house interior and the surrounding nature. Five bedrooms, all with views across the landscape, and two bathrooms with skylights are located on the upper level.

The façades are clad with large-format, vertical Swisspeal panels—the connecting volume in lighter hues of anthracite grey and the other two in darker. The cladding is clipped onto a concrete plinth, which connects the lower vehicular entry level of the site with the rear garden. Larger glass surfaces on the gable ends are recessed behind the eaves and are shielded from the sun with latticework oak cladding. The dark surfaces contrast strongly with the ochre-colored timber, creating an eye-catching graphic impact. As opposed to the three, open gable-ends, the elongated northern side elevation with its black-clad surface is punctured by three, small horizontal windows.

LOCATION: Pot na Črnile, Leskovec pri Krškem, Slovenia

CLIENT: private

ARCHITECTS: SoNo Architects, Ajdovščina and Ljubljana; Edvard Blažko, Marko Volk, Nina Tešanović

BUILDING PERIOD: 2014–2016

GENERAL CONTRACTOR AND FAÇADE CONSTRUCTION: Tesarstvo in krovstvo Emil Jerkovič, Cerklje na Gorenjskem

FAÇADE MATERIAL: Swisspearl Nobilis, 6505 F and 6520 F

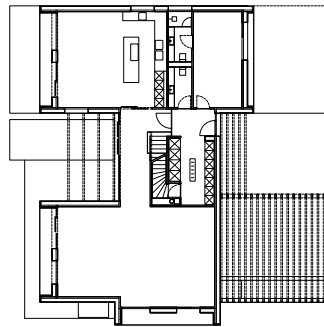

FIRST FLOOR 1:1000

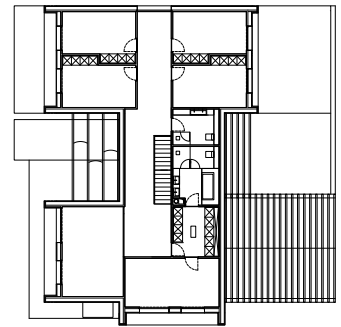

UPPER FLOOR





The strong material contrast between the ochre-colored timber slats and the dark, large-format panels is visually arresting.



A House Angled into a Hillside

House B4, Husseren-les-Chateaux, France

This new, single-family house on the outskirts of a rural village perched between forests to the west and vineyards to the east in the valley below, juxtaposes form and materials in a bold manner.

House B4 is surrounded by wineries, situated on the periphery of the commune Husseren les Chateaux, south of Colmar on the southeastern border in France. An existing old barn on the site was demolished to make way for the modern new house. In order to integrate the building into the landscape, the Vosges sandstone from the demolished barn was reused and reinterpreted in a modern context for the lower level of the house. The project brief includes: the construction of a detached house (without a subterranean basement) and the creation of an open, covered space on the ground floor, which can be used as covered parking.

Occupying the bulk of the site, the complex forms of the house were generated as a response to the irregular shape of the site. Various oblique facets were carefully formed and

the treatment of the façades and large glazed openings positioned to optimize the views of the surrounding landscape, the rear forest, and agricultural valley with vineyards below.

The ground floor accommodates the children's rooms, bathrooms, and an office, as well as the technical areas, boiler room, and laundry. On the upper level are the communal areas—living room, dining room, and open plan kitchen—which extend out onto a spacious timber terrace cantilevered over a swimming pool. A rustic lower level clad in sandstone forms a kind of plinth for the dynamic, freeform, upper level, which is clad in smooth, light beige Swispearl panels. The strong juxtaposition of materials and textures gives the house its strong, contemporary character.



A generous outdoor timber terrace with glazed balustrades open out to the sweeping valley of vineyards below.

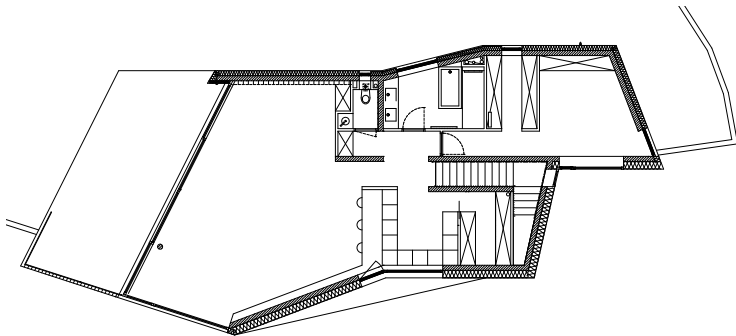

UPPER FLOOR

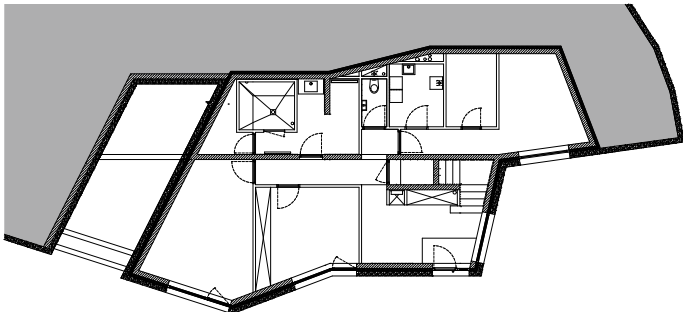

FIRST FLOOR 1:300

LOCATION: 3 rue des Châteaux, Husseren-les-Châteaux, France
 CLIENT: private
 ARCHITECTS: Kauffmann & Wassmer Architectes, Colmar
 BUILDING PERIOD: 2015–2016
 GENERAL CONTRACTOR AND FAÇADE CONSTRUCTION: Renova, Colmar
 FAÇADE MATERIAL: Swisspearl Carat, Onyx 7091





Scenic Setting

Black Villa, Beverly Hills, USA

Black Villa is a combination of state-of-the-art technology and simple, clean design that respects the existing conditions of the site and neighborhood. The single-family house is a great example of how one can use materials and colors in order to tie a building into its natural surroundings.

The design for the villa consists of different volumes with variable heights. A single-story volume with a green roof is orientated eastward, while a double-story section with a green-roof faces northward. The southwest façade has a recessed deck on the lower level with a spacious terrace that connects the house to the infinity pool and Jacuzzi. At the center of the property, the pool allows both privacy and enjoyment of the breathtaking views. The existing tall pine tree is preserved and ties the building into the terrain.

The façade is clad in fire-resistant Swiss-pearl fiber cement panels in a dark charcoal hue. All doors and windows have aluminum frames with dual glazing of high R-value to help reduce energy loss. Deep overhangs and screens over the glazing areas help to protect the structure from the severe Californian sun and help to reduce the use of air conditioning.

These aspects result in a highly efficient and energy-saving design and a house that uses only about 40 to 50 percent the energy of conventionally built homes. The design is based on the LEED (USA energy label) and MINERGIE (Swiss energy certification) guidelines. As far as possible, non-toxic materials were used for the construction. For example, the hardwood is natural oiled wood, the carpet is 100 percent cotton and all paint used is low-toxin.

The sensitive design and playfulness of the volumes, the modest color selection and recessed decks and generous windows complement the beauty of the location. Three volumes at different heights in combination with the balconies, gold cutout screens, and charcoal exterior skin create an interesting play of shapes and volumes, reducing the scale and helping to tie the villa into the site.



Orthogonal, Swisspearl-clad volumes, softened by planters filled with indigenous species, rise up on the rugged hillside site.

LOCATION: Gloaming Way, Beverly Hills, California, USA
CLIENT: Roland Schaellibaum, Beverly Hills
ARCHITECT: Design 21, Roger Kurath M.Arch/SIA, Los Angeles
BUILDING PERIOD: 2014–2017
GENERAL CONTRACTOR: Horizon International, Beverly Hills
FAÇADE CONSTRUCTION: Horizon Steel, Beverly Hills
FAÇADE MATERIAL: Swisspearl Reflex, Black Velvet 9221





The interiors are open, light, and airy and offer spectacular views of the surrounding landscape.

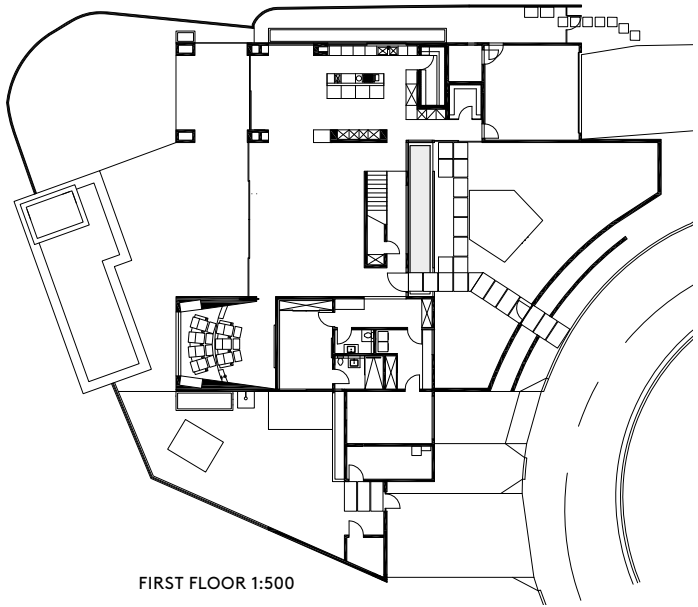
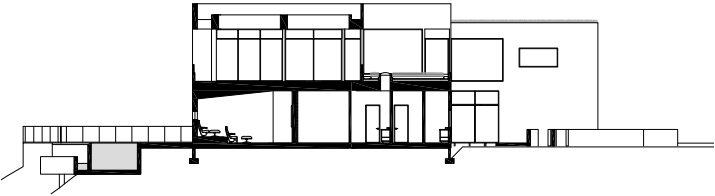

FIRST FLOOR 1:500

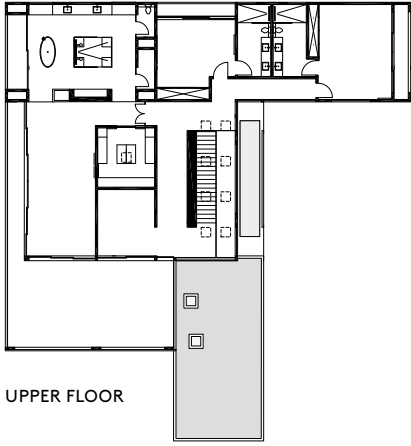

UPPER FLOOR





VARIOUS ARCHITECTS

A Generous Roof Wraps a Complex Form

Villa Faun, Oslo, Norway

What at first glance appears to be a single-family villa enclosed by an enormous pitched-roof with timber-clad eaves, are actually four separate apartment units.

Villa Faun is an apartment complex located in the northwest slope of Oslo with a panoramic view over the city and the Oslo Fjord in the distance. The surrounding neighborhood is characterized by various types of Norwegian houses built during the last century. The concept of the design team was to bring together a unifying identity to the project, while creating private, individual units. The building is carefully positioned on the site and oriented to frame views and natural daylight for indoor and outdoor spaces. Villa Faun has a pitched-roof created according to the functions and surroundings. Together with northern and southern façades, the roof creates a massive, timber-clad envelope. The other two façades contrast with the envelope in form, material, and color and are characterized by playful projections and cut-outs clad in large-format, off-white Swisspearl panels that give individual identity to each unit. This playfulness reduces the scale of the

façades and creates a dynamic form, while the overarching timber envelope balances the overall expression, making Villa Faun appear both calm and playful.

The architecture has a unique character, while at the same time fitting with the surrounding context and the traditional villas in the neighborhood. Due to the sloping terrain, the volumes are designed with split-levels, so that both apartments on the ground floor have direct access to the garden. The split-level also creates extra height for the upper apartments and an extra mezzanine floor within building height regulations.

In order to maximize green areas and create more enjoyable outdoor spaces, the parking garage is located underground. The massive timber envelope is visible in the interior, integrating various functions, including fireplaces, kitchen units, and ventilation, in addition to built-in benches and deep window reveals.

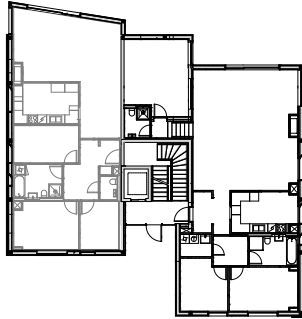
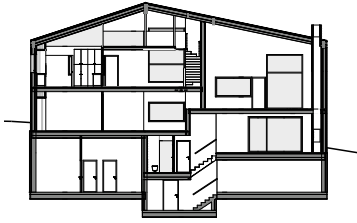

FIRST FLOOR 1:500

LOCATION: Faunveien 7, Oslo, Norway
CLIENT: Nielco, Oslo
ARCHITECTS: Various Architects, Oslo; Isabell Adamofski, Ibrahim Elhayawan, Alexander Berg, Birgitte Haug, Laura Martinez
BUILDING PERIOD: 2016–2017
GENERAL CONTRACTOR AND FAÇADE CONSTRUCTION: Ansnes AS, Hvalstad
FAÇADE MATERIAL: Swisspearl Carat, Onyx 7099 ARSB







Darkly Dramatic and Deconstructed

House RnEve, Mönchhof, Austria

Embedded in a green slope in rural Austria, this unusual, single-family house is uniformly clad in black Swisspearl panels. Like a dark spaceship in a sci-fi film, the dramatic expression of the exterior inclined planes is continued in the interior. Sloping concrete walls and plush built-in velvet settees create a sumptuous, cinematic atmosphere.

The natural incline of the slope was carefully incorporated into the building and is echoed in the main staircase, which connects the three levels internally. The earth-retaining outer wall to the rear defines the building and emphasizes the slope. The narrow outer wall of the main entrance has been built at an incline and, due to the treatment of the façade, merges seamlessly into the visible roof surface of the staircase.

Expressed as a dark volume on the exterior, the building is subdivided horizontally into three layers, where the staircase is an incision but also a connecting element. The house is homogeneously clad in Swisspearl panels throughout; the roof plane, however, is planted with vegetation. The garage and technical equipment of the hillside house are situated on the entrance level. Service spaces, like the laundry, storage, and naturally illuminated winter gardens are located in the intermediary level lead-

ing up to the communal spaces, where the main clothes cupboards are also located. Low, built-in velvety sofas and plush carpets impart the living room with a touch of glamor. Glazed walls open the interior towards the garden, allowing views to the lake and the surrounding vineyards.

Black Swisspearl panels have also been used in the interiors. Clad in Swisspearl panels, the fireplace brings the element of fire visibly into the living and dining areas, while also demarcating the two zones. Inclined planes of concrete walls and ceilings create a neutral background to the built-in interior elements. A large window brings the surrounding natural landscape into the interiors. Horizontal timber slats with visible surfaces clad in Swisspearl panels reduce external noise. RnEve is a dramatic house that stands out prominently in its rural setting.

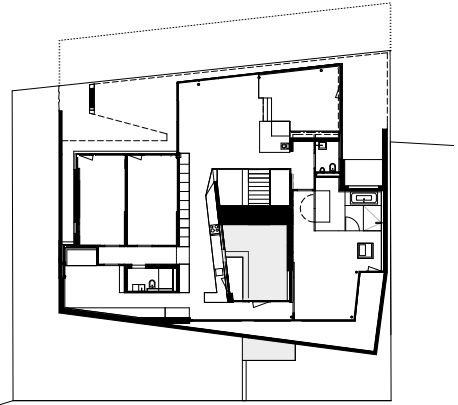
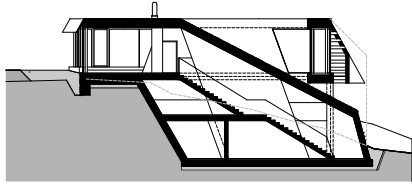

FIRST FLOOR

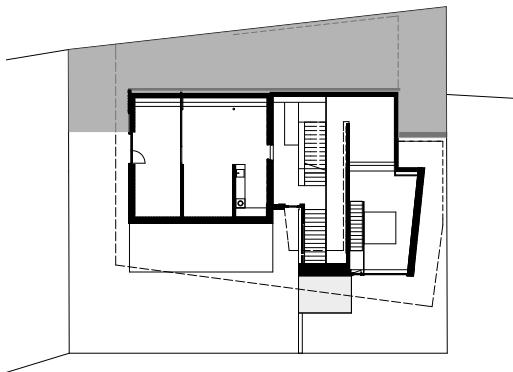

MEZZANINE FLOOR

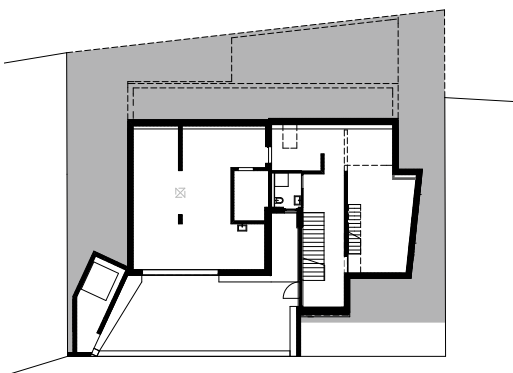

BASEMENT FLOOR 1:500

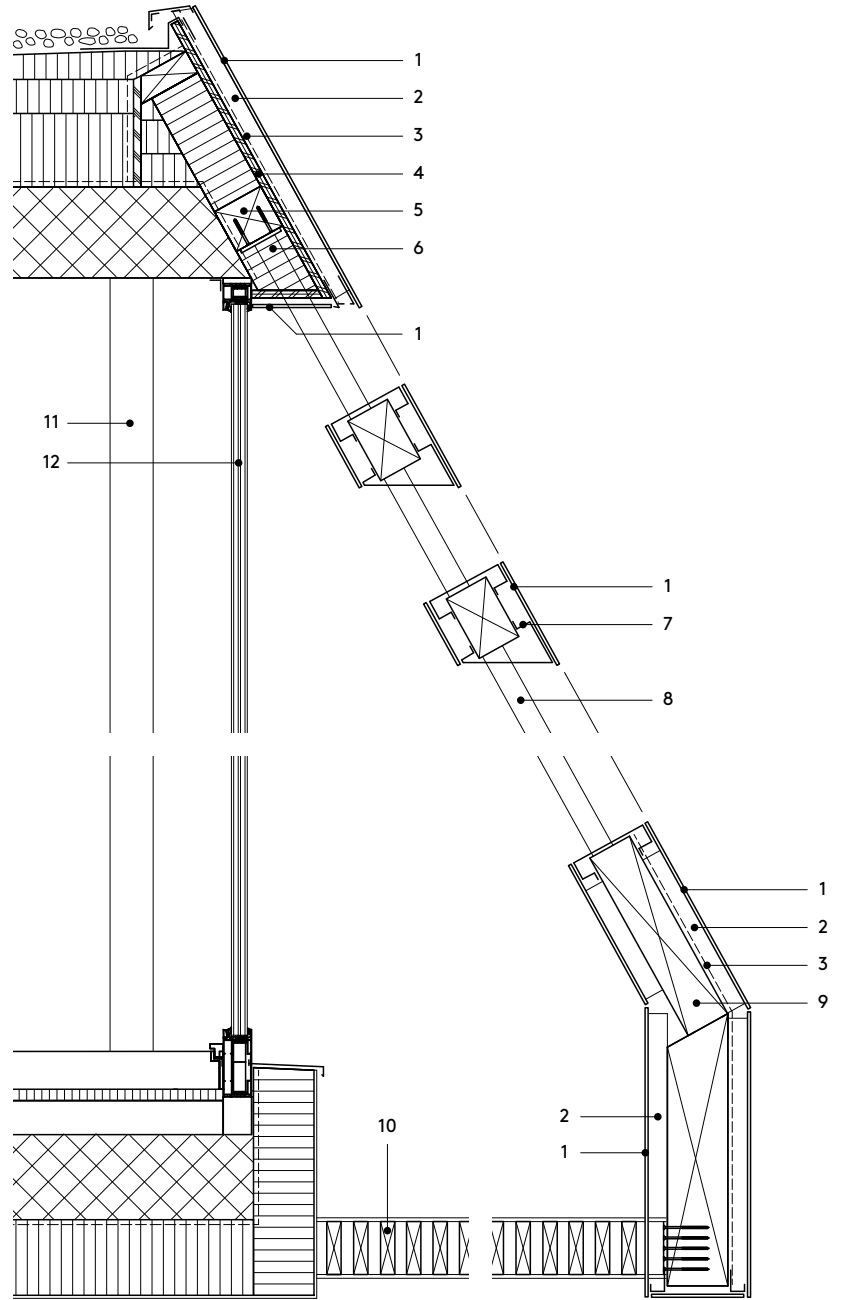

VERTICAL SECTION 1:20

- 1 Swisspearl, 8 mm
- 2 ventilation, vertical subconstruction
- 3 moisture barrier
- 4 oriented structural board
- 5 construction wood for hanging column
- 6 insulation
- 7 shaped aluminum panel
- 8 truss post with mounting straps for lamella beams
- 9 construction wood
- 10 wooden slatted frame
- 11 steel column
- 12 glazing



The fireplace brings the element of fire visibly into the living and dining areas, while low, built-in velvety sofas and plush carpets impart the living room with a touch of glamor.

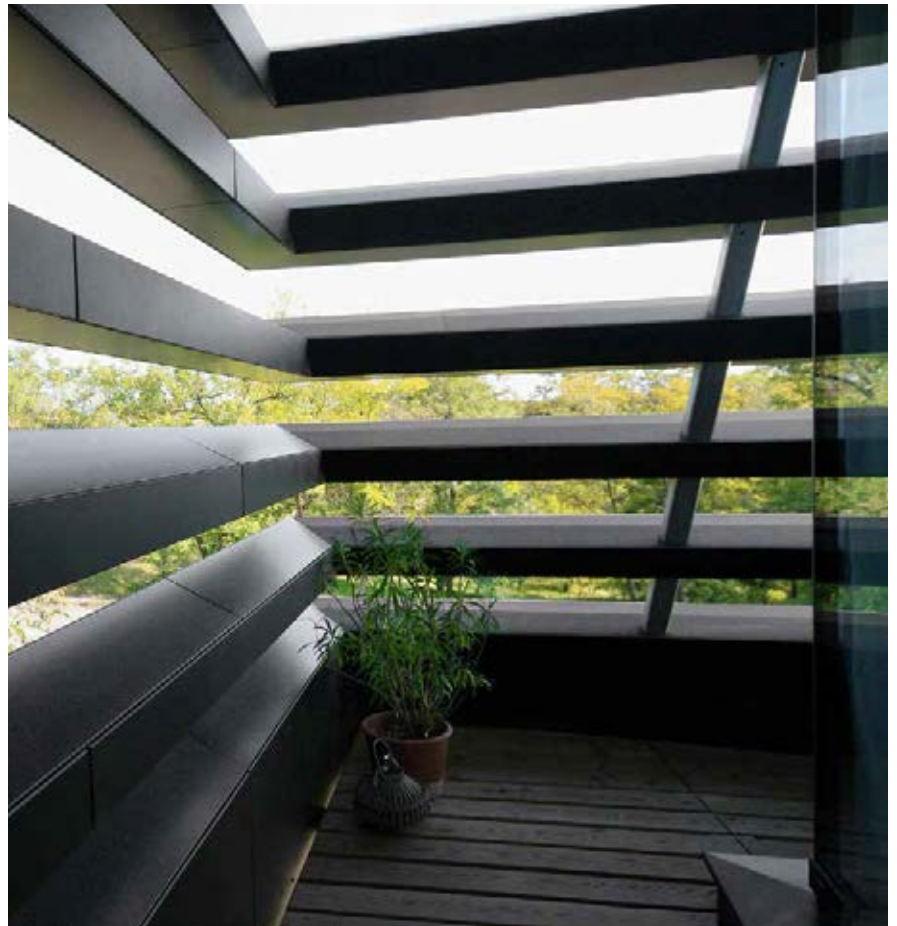



Inclined planes and dynamic forms clad in black Swisspearl panels create a strong, dramatic ensemble.

LOCATION: Mönchhof, Austria
CLIENT: René and Eva Pöckl, Mönchhof
ARCHITECTS: ad2 Architekten, Weiden am See
BUILDING PERIOD: 2012–2013
GENERAL CONTRACTOR: Sattler Brothers, Baumeister Baugesellschaft GmbH, Pamhagen
FAÇADE CONSTRUCTION: Holzbau Kast, Gols
FAÇADE MATERIAL: Swisspearl Carat, Black Opal 7024 (R)

Flash 1

House Attersee, Seewalchen, Austria

Hertl Architekten

House Attersee is situated on a relatively small site close to Attersee Lake in north-west Austria. The deep, cantilevered upper level creates a covered entry forecourt, intended as a kind of covered patio. The rectilinear ensemble consists of the house, garden wall, forecourt, and terraced garden. Wrapped in continuous horizontal bands of Swisspearl panels in three shades of grey, the architecture is cool and abstracted. On entering the building from the street, no fenestration can be seen; the only opening is the front door. All three bedrooms are situated on the lower level, while the communal open plan living, dining, and kitchen areas are above, overlooking the countryside.

LOCATION: Seewalchen, Austria

CLIENT: Hans-Jörg Kasper and Elke Mayrhofer, Seewalchen

ARCHITECTS: Hertl Architekten GmbH, Steyr

BUILDING PERIOD: 2011–2012

FAÇADE CONSTRUCTION: Hausruck-Dach, Ampflwang im Hausruckwald

FAÇADE MATERIAL: Swisspearl Carat, Crystal 6113, 6114 and 7010



Flash 2

Collège Daniel Faucher, Loriol, France

Studio 99

The primary aim in the renovation of Collège Daniel Faucher was to improve the quality of the buildings' thermal envelope. To this end, the external joinery and solar blinds were replaced, while the façade was insulated externally. Projecting white sunscreens made from Swisspearl panels were designed to frame the three bands of fenestration, prevent glare, and reflect high levels of daylight into the interiors. While being a low maintenance design, this solution also echoes the frames of the adjacent buildings and creates a new identity for the campus building. The basic concept was to increase the level of thermal insulation to enhance comfort levels during the summer months, while simultaneously seeking a higher quality architectural coherence for the ensemble of college buildings.

LOCATION: Place Champ de Mars,
Loriol-sur-Drôme, France

CLIENT: Conseil Général de la Drôme

ARCHITECTS: Studio 99, Lyon

BUILDING PERIOD: 2017–2018

FAÇADE CONSTRUCTION: Traversier Sarl,
Saint-Péray

FAÇADE MATERIAL: Swisspearl Carat, Onyx 7090



Flash 3

Industry Building Extension, Carouge, Switzerland

Lin Robbe Seiler

Situated in the heart of Geneva's post-industrial PAV precinct, this commission for a construction material firm required a low-budget renovation of their existing showroom on the first floor as well as the construction of a new stairway and access elevator. Inspired by the architecture of the surrounding warehouse sheds, the project proposes a stacking of translucent volumes containing the staircase that circulates around a central elevator shaft. Lin Robbe Seiler's design creates a striking new entrance pavilion. Clad in dark, undulating, perforated Swisspearl panels and constructed in off-shutter concrete and galvanized steel structures, the pavilion showcases the client's products in a simple and effective manner. The white customer area of the showroom contrasts with the black back-offices and counters.

LOCATION: Rte des Jeunes 87, Carouge, Switzerland

CLIENT: HG Commerciale, Carouge

ARCHITECTS: Lin Robbe Seiler, Geneva

BUILDING PERIOD: 2012–2014

FAÇADE MATERIAL: Swisspearl Ondapress 57 Natura, Vulcanit N 6512

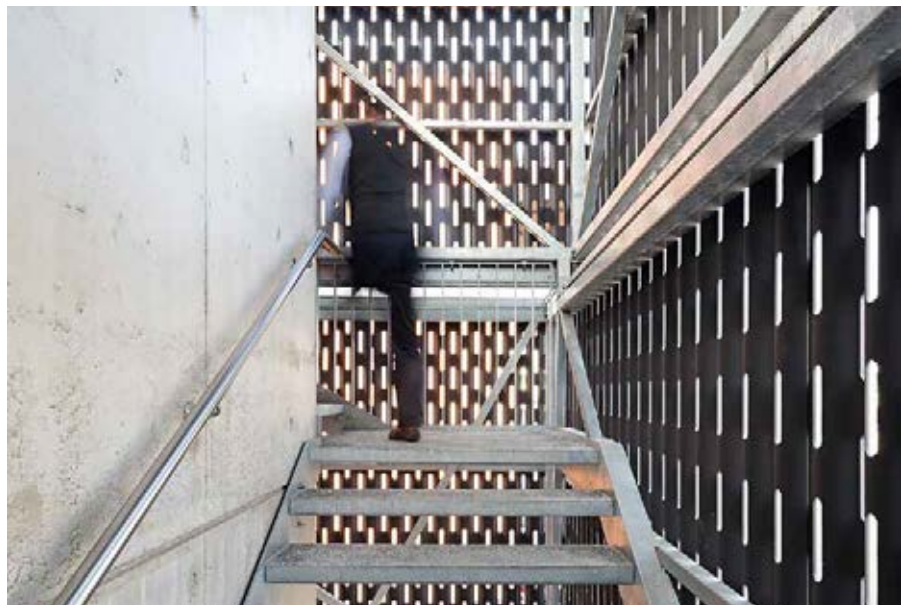

Impressum

The internationally distributed magazine *Swisspearl Architecture* sets Swisspearl fiber cement products within a contemporary architectural context.

Subscription

Swisspearl Architecture Magazine can be ordered, subscribed to, or downloaded: info@swisspearl.com or swisspearl.com/quicklinks/submag

Publisher

Swisspearl
CH-8867 Niederurnen
Switzerland
phone +41 (0)55 617 11 60
info@swisspearl.com
www.swisspearl.com

Advisory board

Michèle Rüegg Hormes, Advisory Council for Architecture, sparc studio
Martin Tschanz, architectural theorist and lecturer ZHAW

Editorial committee

Michael Hanak
Hans-Jörg Kasper
Jürg Schönenberger
Yasmin Willi
Robert Wirichs

Editor

Michael Hanak, Zurich

Editing

Anna Roos, Berne
Marion Elmer, Zurich

Translation

Lisa Rosenblatt, Vienna

Design

Schön & Berger, Zurich

Detail plans

Deck 4, Zurich

Printing company

Buchdruckerei Lustenau, Lustenau

English edition

ISSN 1661-3260

Contacts

Headquarters

Head of Sales | Export, Private Label, OEM
Robert Wirichs
+41 79 644 60 63
robert.wirichs@swisspearl.com

Office Manager Export

Sandra Winteler
+41 55 617 13 34
sandra.winteler@swisspearl.com

Marketing Manager Export

Yasmin Willi
+41 55 617 12 52
yasmin.willi@swisspearl.com

Order Processing

Giuseppe Azzato
+41 55 617 13 54
giuseppe.azzato@swisspearl.com

Head of Transport Disposition

Marlies Gebbs
+41 55 617 13 85
marlies.gebbs@swisspearl.com

Area and Regional Managers

Africa & La Réunion

Laurent Boellinger
+336 7400 12 94
laurent.boellinger@swisspearl.com

Asia Pacific

Robert Wirichs
+41 79 644 60 63
robert.wirichs@swisspearl.com

China, Hong Kong & Taiwan

Chen Wei
+86 186 0175 5719
wei.chen@swisspearl.com

CIS Countries & Russia

Susanna Agne
+43 664 60011313
susanna.agne@swisspearl.com

Denmark & The Netherlands

Robert Wirichs
+41 79 644 60 63
robert.wirichs@swisspearl.com

Eastern Europe

Marjan Ernstschnneider
+386 41 689 662
marjan.ernstschnneider@swisspearl.com

France, Luxembourg, Belgium

Laurent Boellinger
+336 7400 12 94
laurent.boellinger@swisspearl.com

Italy

Enea Spini
+41 79 420 22 93
enea.spini@swisspearl.ch

Norway

Sigurd Sandvik
+47 99 60 90 25
sigurd.sandvik@swisspearl.com

South Eastern Europe

Ivan Simčić
+386 5 39 21 570
ivan.simcic@eternit.si

Sweden

Anders Lindén
+46 703 86 71 60
anders.linden@swisspearl.com

Turkey, India, Near & Middle East

Mustafa Abbasoğlu
+90 533 242 93 82
mustafa.abbasoglu@swisspearl.com

USA & Canada

Harry Harisberger
+1 636 698 5505
harry.harisberger@swisspearl.com

Western Europe & Latin America

Victor Valero
+34 636 610 861
victor.valero@swisspearl.com

Technical Advisors

Asia, Middle East, France, Russia

Hansruedi Leuzinger
+41 79 159 79 10
hansruedi.leuzinger@swisspearl.com

Europe, Latin America, Pacific

Victor Valero
+34 636 610 861
victor.valero@swisspearl.com

USA & Canada

Nick Sturm
+1 760 271 7940
nick.sturm@swisspearl.com

Credits

Photos

Cover page Paúl Rivera, New York
p. 2–8, 10–11, 13–16 Paúl Rivera, New York
p. 9 Pavel Bendov, New York
p. 12 Martin Crook, New York
p. 19–26, 30–35 Andrea Badrutt, Chur
p. 28 Museum für Gestaltung, Designsammlung, ZHdK, Zurich
p. 37–39 Tina Ruisinger, Zurich
p. 40 above Swisspearl, Niederurnen
p. 40 middle Lawrence Anderson, Los Angeles/San Francisco
p. 40 below Meraner & Hauser, Bozen
p. 42–47 Raphaël Thibodeau, Montreal
p. 48–53 Amendolagine Barracchia, Milan
p. 54 Rodrigo Vargas, Mawson/Canberra
p. 56 Ben Wrigley, Melbourne
p. 57 Chalk Studio, Weston
p. 57 Chalk Studio, Weston
p. 58–63 Åke E:son Lindman, Stockholm
p. 64–69 above Meraner & Hauser, Bozen
p. 69 below Elina Matvejeva, Tartu
p. 70–73 Chris Cunningham, Richmond
p. 74–77 Meraner & Hauser, Bozen
p. 78–81 Jürg Zimmermann, Zurich
p. 82–84, 86–87 Michael Hayes, Los Angeles
p. 85 below Bruno Helbling, Zurich
p. 88–90 Meraner & Hauser, Bozen
p. 91 Ibrahim Elhayawan, Oslo
p. 92–96 ad2, Weiden am See
p. 97 Paul Ott, Graz
p. 98 Studio 99, Lyon
p. 99 Radek Brunecky, Zurich
Back page Michael Hayes, Los Angeles

Legal notes

Texts, images, photos and graphic work in this publication are protected by copyright and other intellectual property rights. Rights to the texts are owned by the writers in all cases. The contents of this publication may not be copied, distributed, altered or made available to third parties for commercial purposes. Further, some pages include images the copyrights of which are owned by third parties.

This publication has been assembled with the greatest possible care. Nevertheless, the publisher cannot guarantee freedom from error and the complete accuracy of the information it contains. The plans have been kindly provided by the architects. The detailed plans have been reworked for greater legibility; the editors are not able to guarantee their accuracy.

Colors

Swisspearl offers a great number of different colors and surfaces. The complete current range is shown here. Next to each sample are the page numbers in the current issue where examples of their use can be found.

Carat

	Sahara 7000
	Sahara 7001
	Sahara 7002
	Crystal 7010
	Black Opal 7020
	Black Opal 7021
	Black Opal 7024 → s.p. 92-96
	Black Opal 7025
	Coral 7030 → s.p. 70-73
	Coral 7031 → s.p. 2-16, 58-63
	Coral 7032 → s.p. 58-63
	Coral 7033 → s.p. 58-63
	Azurite 7040
	Azurite 7041
	Jade 7050
	Jade 7052 → s.p. 64-69
	Sapphire 7060 → s.p. 54-57
	Sapphire 7061
	Topaz 7070
	Topaz 7071 → s.p. 58-63
	Topaz 7073 → s.p. 58-63
	Amber 7081 → s.p. 58-63
	Amber 7082 → s.p. 58-63
	Onyx 7090 → s.p. 98
	Onyx 7091 → s.p. 78-81
	Onyx 7099 → s.p. 64-69, 88-91
	Agate 7219

Avera

	AV 000
	AV 010
	AV 020
	AV 030
	AV 040
	AV 050
	AV 060
	AV 070
	AV 100

Reflex

	Silver 9000
	Platinum 9020
	Black Velvet 9221 → s.p. 42-47, 48-53, 82-87
	Dark Silver 9222
	Crimson 9231
	Cobalt Blue 9241

	Autumn Leaves 9270
	Mystic Brown 9271
	Gold 9272
	Champagne 9290
	Satin White 9291

Nobilis

	Black N 012
	White N 112
	Grey N 211
	Grey N 212
	Grey N 213
	Grey N 214
	Grey N 215
	Red N 312
	Blue N 411
	Green N 511
	Green N 513
	Green N 515
	Yellow N 612
	Beige N 811
	Beige N 813
	Brown N 915

Zenor

	11006
	11115
	15015
	23048
	23057
	35005
	35126
	45047
	47030
	51074
	63077
	65061
	67007
	67014
	69046

Incora

	IN 100
	IN 090

Texial

	TE 113
	TE 212
	TE 215
	TE 216
	TE 811

**SWISS
pearl®**



